

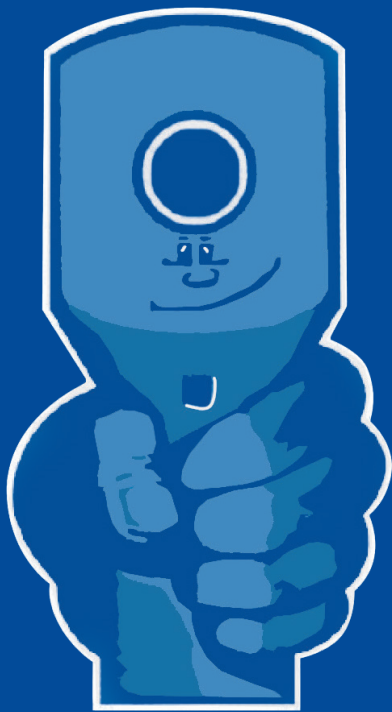

**EGI**®

S.r.l.

CATALOGO GENERALE 2023  
TERMINALI A COMPRESSIONE - TERMINALS





*Passione e Professionalità sono la linfa che da 50 anni  
alimenta la nostra azienda.*

*Sempre attenta a rinnovarsi, ha un unico obiettivo:  
la soddisfazione dei nostri clienti!*

*Insieme saremo capaci di grandi cambiamenti!*

*Roberto Solini*

*Simone Solini*

# ROMANO SAINI

Amministratore Unico

FONDATORE

DA 50 ANNI  
UNA STORIA  
IMPRENDITORIALE  
E PERSONALE  
DI SUCCESSO



1971

Romano Saini, classe 1944, milanese doc, nel 1971 fonda insieme alla moglie la ditta artigiana EGI (Elettro Galvanica Italiana), azienda produttrice di terminali a compressione, di cui è tuttora l'Amministratore Unico.

Grazie ad impegno costante, professionalità e profonda conoscenza del mercato elettrico dovuta ad anni di lavoro sul campo come agente di commercio, Romano Saini ha portato la sua società al traguardo dei **50 anni di fiorente attività**.

Oggi EGI Srl è leader in Italia e in Europa per la sua produzione di terminali a compressione utilizzati in tutto il mondo per le connessioni elettriche di quadri e impianti industriali e infrastrutturali e sempre all'avanguardia nella produzione di articoli innovativi.

La gamma di "capicorda" EGI è la più ampia a livello mondiale, con una qualità costruttiva senza eguali e una capacità produttiva di circa 200.000/300.000 pezzi al giorno.

Le idee visionarie e l'impegno diretto verso l'innovazione continua, hanno fatto sì che Romano Saini dettasse le regole di forma, funzionalità e caratteristiche di alcuni prodotti studiati e realizzati da EGI e unici sul mercato elettrico, quindi riconoscibili dai prodotti della concorrenza ed esportati in tutto il mondo.

1983

Nel 1983 questo impegno verso l'innovazione e l'internazionalizzazione è valso a EGI il conferimento dell'**Ambrogino D'Oro della Camera di Commercio di Milano per le esportazioni e l'Apollo D'Oro 1980 della Camera di Commercio europea per le attività economiche**.

1987

Nel 1987, viene costituita l'attuale forma societaria di EGI Srl e il suo contemporaneo trasferimento nell'attuale sede di Fizzonasco costruita appositamente, all'interno della quale avviene l'intero ciclo produttivo e lo stoccaggio in grandi magazzini per avere sempre prodotti disponibili e garantire consegne tempestive.

1993

Nel 1993 EGI è stata una delle prime aziende italiane a conseguire la certificazione ISO 9001 sui sistemi di qualità. La qualità è infatti uno dei pilastri su cui è fondata la politica aziendale.

Nei primi anni Novanta entrano a far parte dello staff della società le due figlie di Romano Saini. Oggi la più giovane Simona amministra l'azienda a livello commerciale, ma è destinata a prendere in mano totalmente le redini della EGI per guidarla e darle continuità nel prossimo futuro al fine di raggiungere nuovi traguardi e successi.

In tutti questi anni, Romano Saini ha continuato a viaggiare, partecipando a importanti fiere di settore in tutto il mondo e contribuendo con missioni internazionali allo sviluppo e alla promozione delle aziende italiane all'estero, in particolare nel settore elettrico. Questo naturalmente accresce notevolmente la conoscenza dei mercati internazionali dove oggi EGI esporta quasi il **50% della propria produzione**.

Consigliere CONFAPI per oltre 10 anni, socio del Rotary da altrettanti anni e uomo attivo anche nella vita politica e sociale del Paese, Romano Saini è un brillante esempio di successo del panorama imprenditoriale italiano a riprova che dove c'è competenza, creatività ed innovazione si possono raggiungere risultati straordinari.

# A SUCCESSFULL PERSONAL AND BUSINESS HISTORY FOR 50 YEARS!

# ROMANO SAINI

Sole Manager

FOUNDER

1971

*Romano Saini, born in 1944, lover of his city Milan, in 1971, together with his wife, founded the artisan company EGI (Elettro Galvanica Italiana), terminals and lugs manufacturer enterprise, of which he is still the sole administrator.*

*Constant commitment, professional skills and deep knowledge of electrical market gained over long years of work as sales agent, have brought Romano Saini to reach the goal of **50 years anniversary of business with his company.***

*Nowadays EGI is leader in Italy and Europe for the production of terminals and lugs used everywhere for electrical connection of switchboard, industrial and infrastructure plants, and always ahead for the manufacture of innovative products.*

*EGI can boast the worldwide largest and most complete range of terminals, with unmatched quality level and production quantity of about 200.000/300.000 pcs per day.*

*Visionary ideas and continuous innovation commitment, made Romano Saini to dictate shape, functionality and characteristics rules of some products studied and realized by EGI and unique on the electrical market, so easy recognizable from competitors and exported in all over the world.*

1983

*Thanks to this innovation and internationalisation commitment, in 1983 the Milan Chamber of Commerce awarded EGI with the **"Ambrogino D'Oro"** for exports and in 1980 the European Chamber of Commerce awarded the **"Apollo d'Oro"** for economic activities.*

1987

*In 1987, was established the current corporate form of EGI Srl and in the same time the transfer of the company premises in the actual location in Fizzonasco which was especially built. Inside this plant is performed the whole productive process and the storage of goods in very large warehouses to always have available products and so guarantee to customers prompt deliveries.*

1993

*In 1993 EGI was one of the first companies to obtain the ISO 9001 certification for quality systems. Quality is one of the pillar on which company policy is founded.*

*In the early Nineties the two daughter of Romano Saini have joined the EGI staff. Nowadays, the younger one, Simona, manages sales department, but she is destined to take over the whole management of the company to guide it and to give continuity for the near future with the aim to reach new goals and successes.*

*In all these years Romano Saini has travelled, attending important fairs of the electrical sector in all over the world and contributing, with the participation in international missions, to the development and promotion of the Italian companies abroad.*

*In this way, he has considerably increased his knowledge of international markets, where nowadays **EGI exports the 50% of its production.***

*API adviser for over 10 years and Rotary member for as many years, politically and socially active in the Italian life, Romano Saini is a successful business man of the Italian panorama, an example that where there is competence, creativity and innovation, big results can be reached.*

## EGI Srl

**è arrivata al traguardo dei 50 anni di attività nella produzione di terminali a compressione.**

Partita dalla periferia sud di Milano, a Fizzonasco, dove sono tuttora ubicati i suoi stabilimenti, **EGI ha saputo espandersi e farsi conoscere in Italia e nel mondo per la sua vasta gamma di prodotti** e per la sua efficienza nel soddisfare i rapporti con la clientela, trovando per ogni esigenza di connessione elettrica un valido suggerimento e trasformando qualsiasi idea in un prodotto finito.

La gamma standard dei terminali EGI vanta sezioni che vanno da 0,25 a 1.000 mm<sup>2</sup> e, a sua volta, ciascuna sezione ha caratteristiche diversificate in base al foro vite, al preisolamento o alle caratteristiche di forma e funzionalità volte a risolvere qualsiasi tipo di problematica di connessione.

Accanto al "core business" aziendale, che sono appunto i terminali a compressione, ruotano una serie di prodotti vari a completamento della gamma, quali tubetti terminali, pressacavi, fascette, pinze e molto altro, tra cui una nuova produzione di capicorda in acciaio inox che rendono EGI unica nel suo settore.

Proprio la sua longevità ha portato ad una conoscenza profonda del mercato elettrico e la struttura aziendale permette alla società di **poter produrre articoli "fuori catalogo" su specifica richiesta di ogni cliente.**

Inoltre, sono sempre allo studio e alla progettazione articoli nuovi e altamente innovativi che periodicamente vanno ad ampliare la gamma di prodotti standard.

Per questo **EGI è sempre in continua evoluzione e al passo con la crescita tecnologica** dei nostri tempi, sapendo sempre proporre prodotti all'avanguardia e innovativi.

Questa versatilità e la possibilità di andare sempre incontro alle esigenze del cliente è dovuta soprattutto al fatto che l'intero processo produttivo, dalla progettazione all'approvvigionamento della materia prima, dalla produzione al confezionamento e spedizione, sono tutte attività che avvengono all'interno degli stabilimenti EGI.

I capicorda EGI sono realizzati prevalentemente con rame ETP 99,9 e sono tutti sottoposti a trattamento protettivo attraverso la stagnatura elettrolitica mentre per il rivestimento isolante è utilizzato speciale PVC autoestinguento.

**Tutto il processo produttivo segue scrupolosamente le normative vigenti per l'ottenimento di prodotti sicuri e affidabili, sotto la stretta sorveglianza dell'ufficio Controllo Qualità.**

Altro punto fondamentale della politica EGI è di avere un magazzino sempre pronto e rifornito per far fronte all'immediata evasione degli ordini sia in Italia che all'estero.

# 50 ANNI DI CRESCITA!

**EGI FESTEGGIA IL TRAGUARDO  
DEL MEZZO SECOLO DI ATTIVITÀ  
TRA PASSIONE, QUALITÀ  
E PROFESSIONALITÀ**

**Tutti i reparti EGI sono sempre connessi e sinergici tra loro per garantire la puntualità e la qualità nell'evasione degli ordini.** Il lavoro di squadra è una delle funzioni più strategiche, dove ognuno mette in gioco le capacità e le risorse migliori per il conseguimento del fine comune che è la soddisfazione del cliente.

**Una storia umana e imprenditoriale di successo unita a innovazione, tecnologia, ricerca e qualità sono gli ingredienti che hanno portato EGI al traguardo dei 50 anni di attività, oltre alla cura nel creare rapporti straordinari di stima con tutti i suoi interlocutori.**

A questo proposito, **un ringraziamento speciale va a tutti i clienti per averci scelto** e per continuare a riporre in noi la loro fiducia giorno dopo giorno al fine di raggiungere ulteriori traguardi, obiettivi, scelte e cambiamenti.

**ANNIVERSARY**



**EGI**®

S.r.l.

## EGI Srl

has reached the milestone of 50 years of activity in the production of terminals and lugs.

Born on the South outskirts of Milan, Fizzonasco, where its factory is still located, **EGI has been able to expand its activity in Italy and in all over the world thanks to its large range of products** and its efficiency in satisfying customers relationships, always finding a valid suggestion for every kind of electrical connection needs and transforming ideas into finished products.

# 50 YEARS OF GROWTH!

**EGI CELEBRATES HALF CENTURY ACTIVITY GOAL WITH PASSION, QUALITY AND PROFESSIONALITY**

EGI standard range of products can boast section from 0,25 up to 1.000 mm<sup>2</sup>, and each section has different characteristics according to screw hole, pre insulation or shape and functionality features which can solve every electrical connection matters.

Alongside company's core business which are terminals and lugs, there are different other products to complete the range, such as end ferrules, cable glands, cable ties, tools and much more, including a new stainless steel cable lugs production which make EGI unique in its sector.

Thanks to its longevity EGI has a deep knowledge of the electrical market and its structure allows the company **to be able to produce "out of catalogue" items following specific request of each single customer.**

Furthermore EGI is always studying and designing new highly innovative items which periodically enlarge the standard range of products on catalogue.

For this reason EGI is always **in constant evolution and technologically** kept up with the times in proposing innovative and cutting-edge products.

EGI versatility and the possibility to match all customers needs is mainly due to the fact that the whole productive process is performed within EGI plants, from design to raw material supplying, from production to packaging and delivery.

EGI cable lugs are manufactured used mainly copper ETP 99,9 and are all subjected to protective treatment obtained through electrolytic tinning, while special self-extinguishing PVC is used to insulate them.

**Whole productive process carefully follows current regulations to obtain safe and reliable products, under the close supervision of Quality Control office.**

Another key point of EGI policy is to have a warehouse always stocked to face the immediate orders fulfilment both in Italy and abroad.

**All EGI departments are always connected and synergistic with each other to ensure punctuality and quality in orders shipment.** Teamwork is one of the most business strategic functions, where everyone can show their own better resources and skills to achieve the common goal which is the satisfaction of final customer.

**A successful human and business case history joined with innovation, technology, resources and quality are ingredients which have brought EGI to reach the milestone of 50 years of activity, in addition to the care taken in creating extraordinary relationships of esteem with all its interlocutors.**

At this regard, **a special thanks goes to all customers for choosing us** and for continuing to place their trust in us day by day, in order to achieve further milestones, goals, choices and changes.



# 1971-2021

# DALLA MATERIA PRIMA AL CLIENTE FINALE



LE FASI PRODUTTIVE  
CHE PERMETTONO A EGI  
DI CONSEGUIRE  
LA LEADERSHIP IN EUROPA  
NELLA PRODUZIONE  
DI CAPICORDA



## MARCHIO DI IMPRESA REGISTRATO

EGISrl è un marchio depositato e registrato per Marchio d'Impresa. Nel 1993 EGI ha conseguito la Certificazione dei Sistemi delle Aziende CSQ-UNI ISO 9001 che è stata successivamente adeguata alla ISO 9001:2015 (Cert. n. 9105 EGI).

Tutti i terminali sono conformi alle normative CEI-EN 61238-1, al marchio CE, al marchio EAC dell'Unione Eurasiatica e alla direttiva Rohs (2002/95/CE) e successivi aggiornamenti.

## REGISTERED TRADEMARK

*Egi Srl is a registered trademark. In 1993 EGI achieved the CSQ-UNI ISO 9001 Company System Certification for quality which has been subsequently updated according to ISO 9001:2015 (Cert. n. 9105 EGI).*

*All terminals & lugs comply with CEI-EN 61238-1 regulations, to CE mark, to EAC mark of Eurasian Union and to Rhos directive (2002/95/CE) and following updates.*





# FROM RAW MATERIAL TO FINAL CUSTOMER

**PRODUCTION PHASES WHICH ALLOW EGI TO ACHIEVE THE LEADERSHIP IN EUROPE FOR TERMINALS & LUGS PRODUCTION**



La produzione dei terminali a compressione EGI avviene seguendo scrupolosamente le normative comunitarie atte ad ottenere prodotti sicuri e affidabili, con un livello qualitativo alto e nel pieno rispetto e salvaguardia dell'ambiente e della salute.

L'ufficio tecnico e controllo qualità collaborano a stretto contatto per assicurarsi che tutti i processi siano conformi alle normative che regolano il settore elettrico, rinnovando di anno in anno la certificazione sulla qualità.

*The production of EGI terminals scrupulously follow the Community Regulations aimed to obtain reliable and safe products, with high quality level, in full respect and protection of environment and health.*

*Technical and quality control department work closely together to ensure that all processes comply with regulations governing the electrical sector, updating the quality certification year after year.*



KNOW-HOW    dinamicità    CONTROLLO

**IDEE**

RAPIDITÀ



**novità**

QUALITÀ

adattabilità



CREATIVITÀ

QUALITÀ

competenza



**INNOVAZIONE**

AFFIDABILITÀ



PROFESSIONALITÀ

FLESSIBILITÀ

professionalità

DINAMICITÀ

SICUREZZA

serietà

rinnovamento

produttività



**VELOCITÀ**

EFFICIENZA

competenza

automazione

**RICERCA**

# INDICE PRODOTTI PRODUCTS INDEX

CAPICORDA PREISOLATI DA 0,25 A 6 mm <sup>2</sup> PRE-INSULATED TERMINALS FROM 0,25 TO 6 mm <sup>2</sup>	Pag	<b>10 - 18</b>
TUBETTI TERMINALI PREISOLATI E NUDI PREINSULATED AND NON INSULATED END FERRULES	Pag	<b>19 - 20</b>
CAPICORDA NUDI DA 0,25 A 6 mm <sup>2</sup> NON INSULATED END FERRULES FROM 0,25 TO 6 mm <sup>2</sup>	Pag	<b>21 - 27</b>
CAPPUCCI ISOLANTI PER CAPICORDA A INNESTO RAPIDO INSULATING CAPS FOR RAPID CONNECTORS	Pag	<b>28</b>
GIUNTI DI POTENZA POWER BUTT-CONNECTORS	Pag	<b>30</b>
PINZE IDRAULICHE HYDRAULIC TOOLS	Pag	<b>31 - 33</b>
CAPICORDA DI POTENZA IN RAME STAGNATO DA 1,5 A 1.000 mm <sup>2</sup> TINNED COPPER POWER TERMINALS FROM 1,5 A 1.000 mm <sup>2</sup>	Pag	<b>35 - 47</b>
CAPICORDA E GIUNTI DI POTENZA IN ALLUMINIO ALUMINIUM POWER TERMINALS AND JOINTING SLEEVES	Pag	<b>48</b>
CAPICORDA E CONNETTORI MECCANICI CON VITE A ROTTURA SCREW TERMINALS AND CONNECTORS	Pag	<b>49</b>
CAPICORDA BIMETALLICI ALLUMINIO-RAME BIMETALLIC ALUMINIUM-COPPER TERMINALS	Pag	<b>50</b>
CAPICORDA A MORSETTO CABLE CLAMPS	Pag	<b>51</b>
CONNETTORI A "C" "C" CONNECTORS	Pag	<b>52</b>
TRECCE FLESSIBILI FLEXIBLE BRAIDS	Pag	<b>53</b>
MORSETTERIA CABLE CLAMPS	Pag	<b>54 - 55</b>
PRESSACAVI IN OTTONE NICHELATO NICKEL BRASS CABLE GLANDS	Pag	<b>56 - 58</b>
PRESSACAVI IN NYLON NYLON CABLE GLANDS	Pag	<b>59 - 61</b>
PRESSACAVI IN PLASTICA PLASTIC CABLE GLANDS	Pag	<b>62</b>
FASCETTE CABLE TIES	Pag	<b>63 - 65</b>
UTENSILI MECCANICI CRIMPING TOOLS	Pag	<b>66 - 75</b>

# CAPICORDA PREISOLATI 0,25÷6 mm<sup>2</sup>

## PRE-INSULATED TERMINALS 0,25÷6 mm<sup>2</sup>



### MATERIALE

Rame elettrolitico 99,9 stagnato  
Tubetto PVC autoestinguente

TUTTI I CAPICORDA POSSONO ESSERE FORNITI CON BUSSOLA ANTIVIBRANTE IN RAME CHE ASSICURA UNA DOPPIA CONNESSIONE SUL COLLETTO ATTACCATO AL CAVO. AGGIUNGERE -BA DOPO IL CODICE ARTICOLO (ES. A2/P-BA)

### MATERIAL

99,9 tinned electrolytic copper  
Self extinguishing PVC

ALL TERMINALS CAN BE SUPPLIED WITH A SPECIAL ANTI VIBRATION COPPER SLEEVE TO GUARANTEE A DOUBLE CONNECTION ON THE COLLAR ATTACHED TO THE CABLE. ADD -BA AFTER THE ITEM CODE (ES. A2/P-BA)

EAC CE

## CAPICORDA A OCCHIELLO / RING TERMINALS

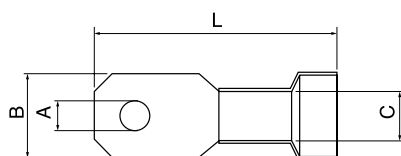

C160/P



C8G/L/P



C65/P ASOLA

ARTICOLO ARTICLE	COLORE COLOUR	SEZIONE WIRE RANGE mm <sup>2</sup>	AWG	Ø A FORO VITE SCREW HOLE	B	C	L	PEZZI PER CONFEZ. PCS PER PACK.	BLISTER con codice a barre with barcode
A2/P	Red	0,25÷1,5	22÷16	2,4	5,7	1,8	18,5	1000	100
A3/P		0,25÷1,5	22÷16	3,6	5,7	1,8	18,5	1000	100
A4/P		0,25÷1,5	22÷16	4,2	7	1,8	19,5	1000	100
A5/P		0,25÷1,5	22÷16	5,2	8	1,8	20,5	1000	100
A6/P		0,25÷1,5	22÷16	6,2	10	1,8	24,5	1000	100
A8/P		0,25÷1,5	22÷16	8,2	12	1,8	25	1000	100
A10/P		0,25÷1,5	22÷16	10,2	13	1,8	28,5	1000	100
B3/P		Blue	1,5÷2,5	16÷14	3,6	6,4	2,4	20,5	1000
B4/P	1,5÷2,5		16÷14	4,2	6,4	2,4	20,5	1000	100
B5/P	1,5÷2,5		16÷14	5,2	8,5	2,4	22	1000	100
B6/P	1,5÷2,5		16÷14	6,2	9,4	2,4	23,5	1000	100
B8/P	1,5÷2,5		16÷14	8,2	13	2,4	29	1000	50
B10/P	1,5÷2,5		16÷14	10,2	13	2,4	29	1000	50
B12/P	1,5÷2,5		16÷14	12,2	18	2,4	35	1000	50
C3/P	Yellow		2,5÷6	12÷10	3,6	6,9	3,6	26	500
C4/P		2,5÷6	12÷10	4,2	8	3,6	26	500	50
C5/P		2,5÷6	12÷10	5,2	10	3,6	26	500	50
C6/P		2,5÷6	12÷10	6,2	10	3,6	26	500	50
C8/P		2,5÷6	12÷10	8,2	14	3,6	31	500	50
C10/P		2,5÷6	12÷10	10,2	14	3,6	31	500	50
C12/P		2,5÷6	12÷10	12,2	18	3,6	38	500	50
C140/P		2,5÷6	12÷10	14,2	24	3,6	42	500	50
C160/P		2,5÷6	12÷10	16,2	24	3,6	42	500	50

### PRODOTTI INNOVATIVI / INNOVATIVE PRODUCTS

C8G/L/P		2,5÷6	12÷10	8,2	15	3,6	32	500	100
C10/G/L/P		2,5÷6	12÷10	10,2	15	3,6	32	500	100
C65/P ASOLA		2,5÷6	12÷10	5 e 6	10,6	3,6	31,5	500	50

Per interruttori con vite imperdibile: occhiello con gancio laterale, adatto a sezioni da 6 mm<sup>2</sup> vite 8 e 10 con zigrinatura antiscivolo. Soluzione intelligente che riduce i tempi di collegamento, garantendo un contatto migliore. Disponibili nudi e preisolati.

For switches with screw with anti-leakage device: ring with lateral hook suitable for wire range 6 mm<sup>2</sup>, screw 8 and 10 with anti slip grooves. An intelligent solution that can reduce connection times and that can guarantee a better contact. Available pre-insulated and not insulated.

Occhiello asolato sezione 4-6 mm<sup>2</sup> per vite da 5 e da 6. Un unico prodotto con doppia funzione. Sostituisce il lavoro che finora potevano fare solo due articoli distinti con foro vite rispettivamente del diametro di 5 o di 6 mm

Ring buttonhole for screw diameter 5 mm and 6 mm and wire range 4-6 mm<sup>2</sup>. It is a single product which performs an operation that until now was only possible by using two different products with screw hole diameter of 5 mm and 6 mm.



# EGI<sup>®</sup>

S.r.l.



## TRE BUONI MOTIVI PER PREFERIRE GLI OCCHIELLI EGI

## THREE GOOD REASONS TO CHOOSE EGI RING TERMINALS

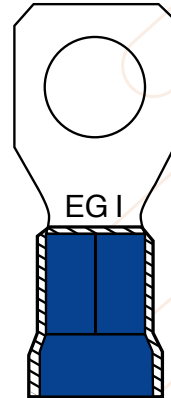

Gli occhielli di produzione EGI sono gli unici sul mercato con forma rettangolare. Questa particolarità, oltre a essere una garanzia di riconoscibilità di produzione italiana, comporta anche notevoli vantaggi funzionali

*EGI ring terminals are the only products on the market with rectangular shape. This specific design is a guarantee of Italian production and adds considerable functionality benefits.*



1 Possibilità di introduzione in spazi limitati  
*Facility to insert in restricted spaces*



2 Autocentratura del terminale  
*Terminal is self-centre locating*



3 Miglior contatto elettrico  
*Better electrical contact*



# CAPICORDA PREISOLATI 0,25÷6 mm<sup>2</sup>

## PRE-INSULATED TERMINALS 0,25÷6 mm<sup>2</sup>

EAC CE



### FORCELLE CON ZIGRINATURA ANTISCIVOLO

La zigrinatura antiscivolo consente una migliore tenuta sulla vite, rendendo il prodotto più sicuro e più facile da utilizzare.

### FORK TERMINALS WITH ANTI SLIP GROOVES

The anti slip grooves provide a better connection on the screw, thus increasing its functionality and safety.

### MATERIALE

Rame elettrolitico 99,9 stagnato  
Tubetto PVC autoestinguente

TUTTI I CAPICORDA POSSONO ESSERE FORNITI CON BUSSOLA ANTIVIBRANTE IN RAME CHE ASSICURA UNA DOPPIA CONNESSIONE SUL COLLETTO ATTACCATO AL CAVO. AGGIUNGERE -BA DOPO IL CODICE ARTICOLO (ES. A2/P-BA)



### MATERIAL

99,9 tinned electrolytic copper  
Self extinguishing PVC

ALL TERMINALS CAN BE SUPPLIED WITH A SPECIAL ANTI VIBRATION COPPER SLEEVE TO GUARANTEE A DOUBLE CONNECTION ON THE COLLAR ATTACHED TO THE CABLE. ADD -BA AFTER THE ITEM CODE (ES. A2/P-BA)

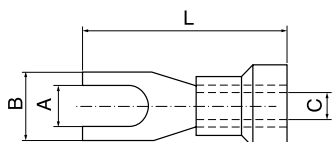
## CAPICORDA A FORCELLA / FORK TERMINALS



PRODOTTI INNOVATIVI INNOVATIVE PRODUCTS	
<b>B135L/P</b> 	Forcella colletto lungo Fork terminal with long neck
<b>A135S/P</b> 	Forcella con blocco tipo "S" Locking fork terminals "S" type
<b>B14L/P</b> <b>B16L/P</b> 	Forcella cava lunga per ponte Long quarry fork terminal

ARTICOLO ARTICLE	COLORE COLOUR	SEZIONE WIRE RANGE mm <sup>2</sup>	AWG	Ø A FORO VITE SCREW HOLE	B	C	L	PEZZI PER CONFEZ. PCS PER PACK.	BLISTER con codice a barre with barcode	
A13/P	Red	0,25÷1,5	22÷16	3	5	1,8	20	1000	100	
A135/P		0,25÷1,5	22÷16	3,5	5,9	1,8	18,5	1000	100	
A135G/P		0,25÷1,5	22÷16	3,5	7,8	1,8	19,5	1000	100	
A135S/P		0,25÷1,5	22÷16	3,5	6,5	1,8	19	1000	100	
A14/P		0,25÷1,5	22÷16	4,1	6,5	1,8	20	1000	100	
A15/P		0,25÷1,5	22÷16	5,2	8,5	1,8	20	1000	100	
A16/P		0,25÷1,5	22÷16	6,2	10,5	1,8	21,5	1000	100	
A18/P		0,25÷1,5	22÷16	8,2	12	1,8	27	1000	100	
B13/P		Blue	1,5÷2,5	16÷14	3	5,5	2,4	20,5	1000	100
B135/P			1,5÷2,5	16÷14	3,5	6,3	2,4	20,5	1000	100
B135G/P	1,5÷2,5		16÷14	3,5	6	2,4	23,5	1000	100	
B135L/P	1,5÷2,5		16÷14	3,5	6,3	2,4	24	1000	100	
B14/P	1,5÷2,5		16÷14	4,1	6,5	2,4	20,4	1000	100	
B14L/P	1,5÷2,5		16÷14	4,1	6,5	2,4	21,4	1000	100	
B14S/P	1,5÷2,5		16÷14	4,1	6,5	2,4	21	1000	100	
B15/P	1,5÷2,5		16÷14	5,2	9	2,4	22	1000	100	
B16/P	1,5÷2,5		16÷14	6,2	10,5	2,4	24	1000	100	
B16L/P	1,5÷2,5		16÷14	6,2	10,5	2,4	25	1000	100	
B18/P	1,5÷2,5	16÷14	8,2	12	2,4	27	1000	100		
B110/P	1,5÷2,5	16÷14	10,2	13,5	2,4	28	1000	50		
B112/P	1,5÷2,5	16÷14	12,2	18	2,4	35	1000	50		
C13/P	Yellow	2,5÷6	12÷10	3,5	6,9	3,6	26	500	50	
C14/P		2,5÷6	12÷10	4,3	8	3,6	27	500	50	
C14S/P		2,5÷6	12÷10	4,1	8	3,6	24	500	50	
C15/P		2,5÷6	12÷10	5,2	10,5	3,6	28	500	50	
C16/P		2,5÷6	12÷10	6,4	11,5	3,6	30	500	50	
C18/P		2,5÷6	12÷10	8,5	13	3,6	31	500	50	
C110/P		2,5÷6	12÷10	10,5	15	3,6	31	500	50	
C112/P		2,5÷6	12÷10	12,2	18	3,6	38	500	50	

## PINZE CONSIGLIATE PER LA CRIMPATURA DEI TERMINALI PREISOLATI PER SEZIONI DA 0,25 A 6 mm<sup>2</sup>

### TOOLS SUGGESTED FOR CRIMPING PRE INSULATED TERMINALS WIRE RANGE FROM 0,25 TO 6 mm<sup>2</sup>



### ART. 60

Pinza a cricchetto per preisolati 0,25 a 6mm<sup>2</sup>. Doppia aggraffatura + punzone controllo qualità.  
Ratchet tool for insulated terminals 0,25 to 6 mm<sup>2</sup>. Double crimping + quality control punch.



### ART. 54

Pinza per capicorda preisolati doppia aggraffatura da 0,25 a 6 mm<sup>2</sup>. Taglia e spella fili.  
Tool for insulated terminals double crimping from 0,25 up to 6 mm<sup>2</sup>. Cut and wire stripper.



### ART. 53

Pinza per capicorda nudi e preisolati da 0,25 a 6 mm<sup>2</sup>.  
Tool for insulated and not insulated terminals from 0,25 up to 6 mm<sup>2</sup>.



# EGI<sup>®</sup>

S.r.l.



## PINZA A CRICCHETTO PER CAPICORDA PREISOLATI DA 0,25 A 6 mm<sup>2</sup>

### RATCHET TOOL

FOR INSULATED TERMINALS WIRE RANGE FROM 0,25 TO 6 mm<sup>2</sup>



ART. 60

#### SOLO VANTAGGI! ONLY ADVANTAGES!

- Punzonatura per controllo qualità sul lavoro svolto
- *Punching insures quality control during the manufacture*
- Doppia aggraffatura
- *Double crimping*
- Testa affusolata per introduzione in spazi ridotti
- *Tapered head to aid insertion in tight spaces*
- Manico allungato per facilitare la crimpatura e consentire l'appoggio su superficie
- *Lengthened grip for easy crimping*

#### IN COSA CONSISTE LA PUNZONATURA CONTROLLO QUALITA' WHAT IS THE CONTROL QUALITY PUNCHING

Questa funzione permette all'utilizzatore della pinza di capire fino a che punto la crimpatura con il cavo è perfetta. Ad ogni sezione corrisponde una lettera:

● Giallo=E      ● Blu=G      ● Rosso=I

In fase di aggraffatura sul tubetto in PVC viene stampata la lettera che corrisponde alla sezione.

Fino a che si leggerà la stampa della lettera corrispondente la crimpatura sarà perfetta, quando la stampa si deteriorerà, non verrà più garantita la sicurezza di tenuta sul cavo.

*The punching quality control function, alerts the operator when the crimping of the cable is complete.*

*Each wire range corresponds to a specific letter:*

● Yellow=E      ● Blue=G      ● Red=I

*During the crimping phase on the pvc tube, a letter, which correspond to the cross section, will be printed on the PVC. The crimping is accepted once the letter is clearly readable, if the letter is unreadable, it notifies the operator of a failed crimp.*



EGI SRL - Via Gobetti, 44 - 20072 Fizzonasco di Pieve Emanuele (MI)

Tel. 02/90.72.19.44 - Fax 02/90.72.46.46 - e-mail: info@egisrl.it - www.egisrl.it

# CAPICORDA PREISOLATI AD INNESTO RAPIDO 0,25÷6 mm<sup>2</sup>

## PRE-INSULATED QUICK TERMINALS 0,25÷6 mm<sup>2</sup>



### MATERIALE

Ottone stagnato con bussola antivibrante in rame  
Tubetto PVC autoestinguente

### TIPO

Femmina

### MATERIAL

Tinned brass with antivibration copper sleeve  
self extinguishing PVC

### TYPE

Female

EAC CE

## FEMMINA PREISOLATA / PREINSULATED FEMALE

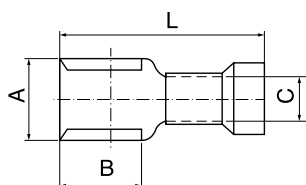

ARTICOLO ARTICLE	COLORE COLOUR	SEZIONE WIRE RANGE mm <sup>2</sup>	AWG	LINGUETTA TONGUE A	B	C	L	PEZZI PER CONFEZ. PCS PER PACK.	BLISTER con codice a barre with barcode
A00/P	Red	0,25÷1,5	22÷16	2,8x0,8	6	1,8	19	1000	100
A01/P		0,25÷1,5	22÷16	4,8x0,8	6	1,8	19	1000	100
A02/P		0,25÷1,5	22÷16	6,3x0,8	7,8	1,8	21	1000	100
A03/P		0,25÷1,5	22÷16	5,2x0,8	7,8	1,8	20	1000	100
A04/P		0,25÷1,5	22÷16	2,8x0,5	6	1,8	19	1000	100
A05/P	0,25÷1,5	22÷16	4,8x0,5	6	1,8	19	1000	100	
A08/P	0,25÷1,5	22÷16	7,9x0,8	9,5	1,8	22,5	1000	100	
B00/P	Blue	1,5÷2,5	16÷14	2,8x0,8	6	2,3	19	1000	100
B01/P		1,5÷2,5	16÷14	4,8x0,8	6	2,3	19,5	1000	100
B02/P		1,5÷2,5	16÷14	6,3x0,8	7,8	2,3	21	1000	100
B03/P		1,5÷2,5	16÷14	5,2x0,8	7,8	2,3	21	1000	100
B04/P		1,5÷2,5	16÷14	2,8x0,5	6	2,3	19	1000	100
B05/P	1,5÷2,5	16÷14	4,8x0,5	6	2,3	19,5	1000	100	
B08/P	1,5÷2,5	16÷14	7,9x0,8	9,5	2,3	22,5	1000	100	
C01/P	Yellow	2,5÷6	12÷10	4,8x0,8	6	3,4	21	500	50
C02/P		2,5÷6	12÷10	6,3x0,8	7,8	3,4	24	500	50
C09/P		2,5÷6	12÷10	9,9x1	12,5	3,4	28	500	50

## FEMMINA TOTALMENTE ISOLATA / FULLY INSULATED FEMALE

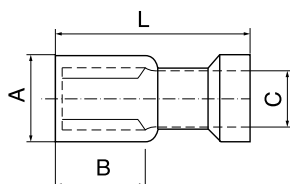

ARTICOLO ARTICLE	COLORE COLOUR	SEZIONE WIRE RANGE mm <sup>2</sup>	AWG	LINGUETTA TONGUE A	B	C	L	PEZZI PER CONFEZ. PCS PER PACK.	BLISTER con codice a barre with barcode
A00T/P	Red	0,25÷1,5	22÷16	2,8x0,8	6	1,8	18,5	1000	100
A01T/P		0,25÷1,5	22÷16	4,8x0,8	6	1,8	20	1000	100
A02T/P		0,25÷1,5	22÷16	6,3x0,8	7,8	1,8	21	1000	100
A04T/P		0,25÷1,5	22÷16	2,8x0,5	6	1,8	18,5	1000	100
A05T/P		0,25÷1,5	22÷16	4,8x0,5	6	1,8	20	1000	100
B00T/P	Blue	1,5÷2,5	16÷14	2,8x0,8	6	2,3	20	1000	100
B01T/P		1,5÷2,5	16÷14	4,8x0,8	6	2,3	20	1000	100
B02T/P		1,5÷2,5	16÷14	6,3x0,8	7,8	2,3	22	1000	100
B05T/P		1,5÷2,5	16÷14	4,8x0,5	6	2,3	20	1000	100
C02T/P		Yellow	2,5÷6	12÷10	6,3x0,8	7,8	3,4	24	500



# CAPICORDA PREISOLATI AD INNESTO RAPIDO 0,25÷6 mm<sup>2</sup>

## PRE-INSULATED QUICK TERMINALS 0,25÷6 mm<sup>2</sup>



**MATERIALE**  
Rame elettrolitico 99,9 stagnato  
Tubetto PVC autoestinguente

**MATERIAL**  
99,9 tinned electrolytic copper  
Self extinguishing PVC

EAC CE

### MASCHIO PREISOLATO / PREINSULATED MALE

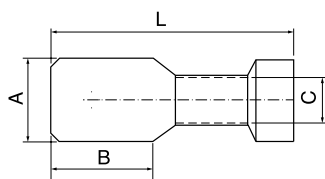

ARTICOLO ARTICLE	COLORE COLOUR	SEZIONE WIRE RANGE mm <sup>2</sup>	AWG	LINGUETTA TONGUE A	B	C	L	PEZZI PER CONFEZ. PCS PER PACK.	BLISTER con codice a barre with barcode
A22/P	Red	0,25÷1,5	22÷16	6,3x0,8	8	1,8	21	1000	100
A32/P		0,25÷1,5	22÷16	4,8x0,8	8	1,8	20	1000	100
B22/P	Blue	1,5÷2,5	16÷14	6,3x0,8	8	2,3	21	1000	100
B32/P		1,5÷2,5	16÷14	4,8x0,8	8	2,3	20	1000	100
B35/P	Blue	1,5÷2,5	16÷14	4,8x0,5	8	2,7	20	1000	100
C22/P		2,5÷6	12÷10	6,3x0,8	8	3,6	23	500	50
C29/P	Yellow	2,5÷6	12÷10	9,9x1	9,9	3,6	26	500	50

### MASCHIO TOTALMENTE ISOLATO / FULLY INSULATED MALE

**MATERIALE**  
Ottone stagnato  
Tubetto PVC  
autoestinguente

**MATERIAL**  
Tinned brass  
Self extinguishing PVC

ARTICOLO ARTICLE	COLORE COLOUR	SEZIONE WIRE RANGE mm <sup>2</sup>	AWG	LINGUETTA TONGUE A	B	C	L	PEZZI PER CONFEZ. PCS PER PACK.	BLISTER con codice a barre with barcode
A22T/P	Red	0,25÷1,5	22÷16	6,3x0,8	10,4	1,8	23	1000	50
B22T/P	Blue	1,5÷2,5	16÷14	6,3x0,8	10,4	2,3	23	1000	50
C22T/P	Yellow	2,5÷6	12÷10	6,3x0,8	10,4	3,4	26,5	500	50

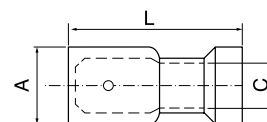

### RACCORDO MISTO (MASCHIO+FEMMINA) / QUICK CONNECT MALE+FEMALE

**MATERIALE**  
Ottone stagnato  
con bussola  
antivibrante in rame  
Tubetto PVC  
autoestinguente

**TIPO**  
Maschio e femmina

**MATERIAL**  
Tinned brass with  
antivibration  
copper sleeves  
Self extinguishing PVC

**TYPE**  
Male and female

ARTICOLO ARTICLE	COLORE COLOUR	SEZIONE WIRE RANGE mm <sup>2</sup>	AWG	LINGUETTA TONGUE A	B	C	L	PEZZI PER CONFEZ. PCS PER PACK.	BLISTER con codice a barre with barcode
A30/P	Red	0,25÷1,5	22÷16	6,3x0,8	7,8	1,8	22,2	1000	50
B30/P	Blue	1,5÷2,5	16÷14	6,3x0,8	8	2,3	23	1000	50
C30/P	Yellow	2,5÷6	12÷10	6,3x0,8	8	3,6	26	500	50

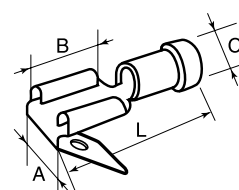

# CAPICORDA PREISOLATI AD INNESTO RAPIDO 0,25÷6 mm<sup>2</sup>

## PRE-INSULATED QUICK TERMINALS 0,25÷6 mm<sup>2</sup>



### MATERIALE

Ottone stagnato con bussola antivibrante in rame  
Tubetto PVC autoestinguente

### TIPO

Maschio e femmina

### MATERIAL

Tinned brass with antivibration copper sleeve  
self extinguishing PVC

### TYPE

Male and female

EAC CE

## SPINA CILINDRICA FEMMINA / FEMALE SOCKET

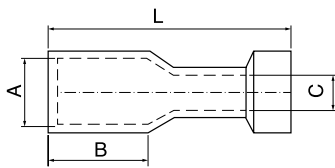

ARTICOLO ARTICLE	COLORE COLOUR	SEZIONE WIRE RANGE mm <sup>2</sup>	AWG	Ø A FORO VITE SCREW HOLE	B	C	L	PEZZI PER CONFEZ. PCS PER PACK.	BLISTER con codice a barre with barcode
A69/P	Red	0,25÷1,5	22÷16	4	8,7	1,8	23	1000	50
B69/P	Blue	1,5÷2,5	16÷14	5	8,7	2,3	23	1000	50
C69/P	Yellow	2,5÷6	12÷10	5	8,7	3,6	28	500	50

## SPINA CILINDRICA MASCHIO / MALE SOCKET

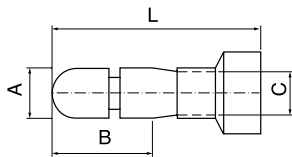

ARTICOLO ARTICLE	COLORE COLOUR	SEZIONE WIRE RANGE mm <sup>2</sup>	AWG	Ø A FORO VITE SCREW HOLE	B	C	L	PEZZI PER CONFEZ. PCS PER PACK.	BLISTER con codice a barre with barcode
A96/P	Red	0,25÷1,5	22÷16	4	8,7	1,8	21	1000	100
B96/P	Blue	1,5÷2,5	16÷14	5	8,7	2,3	21	1000	100
C96/P	Yellow	2,5÷6	12÷10	5	8,7	3,6	24	500	50

## CONNETTORI DI TESTA RICAVATI DA TUBO RAME / BUTT CONNECTORS COPPER TINNED TUBE

### MATERIALE

Tubo rame 99,9  
Tubetto PVC  
autoestinguente

### MATERIAL

Copper tube 99,9  
Self extinguishing  
PVC

ARTICOLO ARTICLE	COLORE COLOUR	SEZIONE WIRE RANGE mm <sup>2</sup>	AWG	B	C	L	PEZZI PER CONFEZ. PCS PER PACK.	BLISTER con codice a barre with barcode
A20/P	Red	0,25÷1,5	22÷16	5	1,8	26	1000	100
B20/P	Blue	1,5÷2,5	16÷14	5,5	2,4	26	1000	100
C20/P	Yellow	2,5÷6	12÷10	7	3,6	27	500	50
D20/P	Red	10	8÷7	8,4	4,6	43	500	50

A richiesta possono essere forniti con isolante in nylon / On request can be supplied with NYLON insulation

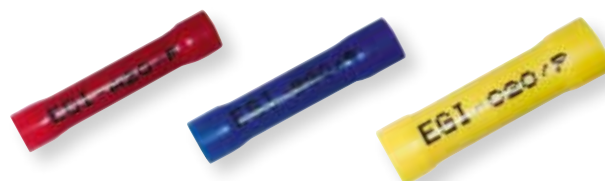
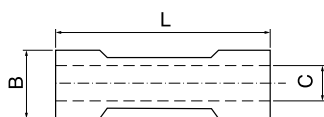

A RICHIESTA DISPONIBILI ANCHE TERMO-RETRATTILI  
ON REQUEST AVAILABLE ALSO SHRINK HEAT SLEEVE

# CAPICORDA PREISOLATI AD INNESTO RAPIDO 0,25÷6 mm<sup>2</sup>

## PRE-INSULATED QUICK TERMINALS 0,25÷6 mm<sup>2</sup>

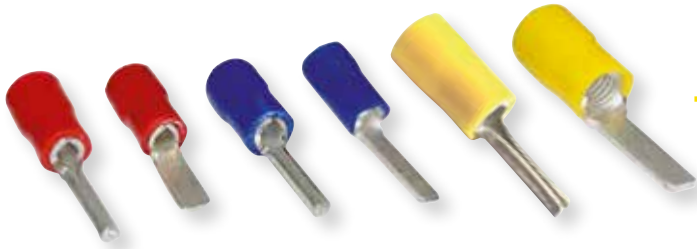

**MATERIALE**  
Rame elettrolitico 99,9 stagnato  
Tubetto PVC autoestinguente

**MATERIAL**  
Tinned electrolytic copper 99,9  
Self extinguishing PVC

EAC CE

### PUNTALE ROTONDO PREISOLATO / PREINSULATED ROUND PIN TERMINAL

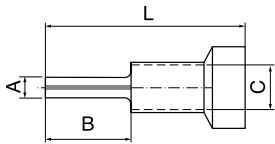

Puntale  
rotondo

ARTICOLO ARTICLE	COLORE COLOUR	SEZIONE WIRE RANGE mm <sup>2</sup>	AWG	Ø A	B	C	L	PEZZI PER CONFEZ. PCS PER PACK.	BLISTER con codice a barre with barcode
A1C/P	Red	0,25÷1,5	22÷16	1,7	9	1,8	20,5	1000	100
A1/P		0,25÷1,5	22÷16	1,7	11	1,8	22,5	1000	100
B1C/P	Blue	1,5÷2,5	16÷14	1,8	9	2,3	19	1000	100
B1/P		1,5÷2,5	16÷14	1,8	11	2,3	22	1000	100
C1/P	Yellow	2,5÷6	12÷10	2,6	13	3,6	27,5	500	50

### PUNTALE PIATTO PREISOLATO / PREINSULATED FLAT PIN TERMINAL

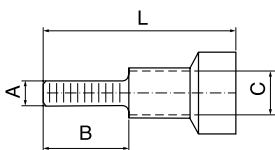

Puntale  
piatto



B11G/P

ARTICOLO ARTICLE	COLORE COLOUR	SEZIONE WIRE RANGE mm <sup>2</sup>	AWG	Ø A	B	C	L	PEZZI PER CONFEZ. PCS PER PACK.	BLISTER con codice a barre with barcode
A11/P	Red	0,25÷1,5	22÷16	3	12	1,8	22	1000	100
A11C/P		0,25÷1,5	22÷16	3	9	1,8	19	1000	100
A11G/P (gancio)		0,25÷1,5	22÷16	3	17	1,8	27	1000	100
A11L/P		0,25÷1,5	22÷16	2,5	17	1,8	28	1000	100
B11/P	Blue	1,5÷2,5	16÷14	3	12	2,3	24,5	1000	100
B11L/P		1,5÷2,5	16÷14	2,5	17	2,3	28	1000	100
B11G/P (gancio)		1,5÷2,5	16÷14	3	17	2,3	27,5	1000	100
C11C/P	Yellow	2,5÷6	12÷10	3,9	9	3,6	25	500	50
C11/P		2,5÷6	12÷10	3,9	13	3,6	30	500	50

# VALIGETTA ASSORTITA CON CAPICORDA PREISOLATI E PINZA

## TOOL KIT AND PRE-INSULATED TERMINALS



ART. 52



ART. 53



ART. 54



ART. 60

ART. / ART.	DESCRIZIONE / DESCRIPTION
AZ 0	Valigetta vuota / Empty bag
AZ 1	Assortimento terminali e pinza ART. 53 <i>Terminals choice and tool ART. 53</i>
AZ 2	Assortimento terminali e pinza ART. 54 <i>Terminals choice and tool ART. 54</i>
AZ 3	Assortimento terminali senza pinza <i>Terminals choice without tool</i>
AZ 4	Assortimento terminali e pinza ART. 60 <i>Terminals choice and tool ART. 60</i>
AZ 5	Assortimento terminali nudi e pinza ART. 52 <i>Not insulated terminals choice and tool ART. 52</i>

### ASSORTIMENTO STANDARD VALIGETTA MODELLO AZ 1 - AZ 2 - AZ 3 E AZ 4

N. 10 scomparti per una capienza massima di circa 500 pz totali

### STANDARD BAG ASSORTMENT OF MOD. AZ 1 - AZ 2 - AZ 3 AND AZ 4

N. 10 divisions for a maximum capacity of 500 pcs

50 pz/pcs C 1/P	50 pz/pcs A 13/P
50 pz/pcs C 6/P	50 pz/pcs A 16/P
50 pz/pcs C14/P	50 pz/pcs B 1/P
50 pz/pcs A 1/P	50 pz/pcs B 4/P
50 pz/pcs A 4/P	50 pz/pcs B 14/P

PER RIVENDITORI / FOR RETAILERS

## NUOVO ESPOSITORE DA PARETE NEW WALL EXHIBITION

Nuovo espositore da parete con logo EGI per disporre in modo ordinato i nostri blister!

*New wall exhibitor with EGI brand to arrange our blister!*



# TUBETTI TERMINALI PREISOLATI PRE-INSULATED END FERRULES



● **MATERIALE**  
Rame elettrolitico 99,9 stagnato

● **MATERIAL**  
99,9 tinned electrolytic copper

**COLORAZIONE A NORMA  
DIN 42628/4**

**COLOURS COMPLIANT TO  
DIN 42628/4**



## TUBETTI TERMINALI PREISOLATI / PRE INSULATED END FERRULES

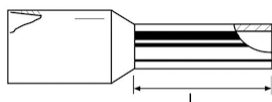

### ART. 39

Pinza per tubetti nudi e preisolati da 0,5 a 6 mm<sup>2</sup>  
Tool for insulated and not insulated ferrules 0,5 to 6 mm<sup>2</sup>



### ART. 40

Pinza per tubetti nudi e preisolati da 0,5 a 6 mm<sup>2</sup>  
Tool for insulated and not insulated ferrules 0,5 to 6 mm<sup>2</sup>

ARTICOLO ARTICLE	COLORE COLOUR	SEZIONE WIRE RANGE mm <sup>2</sup>	LUNGHEZZA LENGTH	PEZZI PER CONFEZ. PCS PER PACK.
501		0,25	6	500
502		0,50	8	500
502/10		0,50	10	500
503		0,75	8	500
503/12		0,75	12	500
504		1	8	500
504/12		1	12	500
505		1,5	8	500
505/12		1,5	12	500
505L		1,5	10	500
506		2,5	8	500
506L		2,5	12	500
507		4	10	500
507L		4	18	500
508		6	12	100
508L		6	18	100
509		10	12	100
509L		10	18	100
510		16	12	100
510L		16	18	100
511		25	16	50
512		35	16	50
513		50	20	50
514		70	21	25
515		95	25	25
516		120	27	25
517		150	32	25

## TUBETTI TERMINALI PREISOLATI DOPPIO INVITO / PRE INSULATED TWIN WIRE END FERRULES

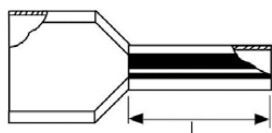

### ART. 41

Pinza per tubetti nudi e preisolati da 6 a 16 mm<sup>2</sup>  
Tool for insulated and not insulated ferrules 6 to 16 mm<sup>2</sup>



ARTICOLO ARTICLE	COLORE COLOUR	SEZIONE WIRE RANGE mm <sup>2</sup>	LUNGHEZZA LENGTH	PEZZI PER CONFEZ. PCS PER PACK.
502/2		0,50	8	500
503/2		0,75	8	500
503/2L		0,75	10	500
504/2		1	8	500
504/2L		1	10	500
505/2		1,5	8	500
505/2L		1,5	12	500
506/2		2,5	10	500
506/2L		2,5	13	500
507/2		4	12	100
508/2		6	14	100
509/2		10	14	100
510/2		16	14	100

# TUBETTI TERMINALI PREISOLATI SERIE IN BOBINA

## PRE-INSULATED END FERRULES REEL SERIES



● **MATERIALE**  
Rame elettrolitico 99,9 stagnato

● **MATERIAL**  
99,9 tinned electrolytic copper

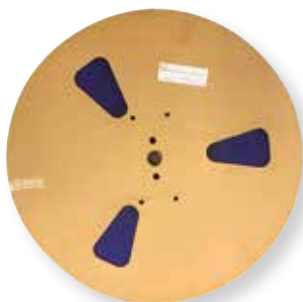

COLORAZIONE A NORMA DIN 42628/4  
COLOURS COMPLIANT TO DIN 42628/4

ARTICOLO ARTICLE	COLORE COLOUR	SEZIONE WIRE RANGE mm <sup>2</sup>	LUNGHEZZA LENGTH	PEZZI PER CONFEZ. PCS PER PACK.
502/3/4		0,50	8	bobina 10.000
503/3/4		0,75	8	bobina 10.000
504/3/4		1	8	bobina 7.500
505/3/4		1,5	8	bobina 7.500
506/3/4		2,5	8	bobina 5.000

## TUBETTI TERMINALI NUDI / NON INSULATED END FERRULES



● **MATERIALE**  
Rame elettrolitico stagnato  
Tubetti utilizzati per fissaggio sicuro di cavetti flessibili in condizioni particolari di spazio limitato

● **MATERIAL**  
Tinned electrolytic copper  
Ferrules used to connect safely small flexible cables in particular conditions of limited area

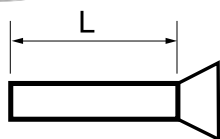

CONFORMI ALLA NORMATIVA DIN 46228/1  
COMPLIANT TO DIN 46228/1

### ART. 42

Pinza per tubetti nudi e preisolati da 25 a 50 mm<sup>2</sup>  
Tool for insulated and non insulated ferrules 25 to 6 mm<sup>2</sup>



### ART. 43

Pinza per tubetti nudi e preisolati da 50 a 95 mm<sup>2</sup>  
Tool for insulated and non insulated ferrules 50 to 95 mm<sup>2</sup>



### ART. 102/T

Pinza per tubetti nudi e preisolati da 0,25 a 2,5 mm<sup>2</sup>  
Tool for insulated and non insulated ferrules 0,25 to 2,5 mm<sup>2</sup>



### ART. 103/T

Pinza per tubetti nudi e preisolati da 0,75 a 10 mm<sup>2</sup>  
Tool for insulated and non insulated ferrules 0,75 to 10 mm<sup>2</sup>



ARTICOLO ARTICLE	SEZIONE WIRE RANGE mm <sup>2</sup>	LUNGHEZZA LENGTH L	PEZZI PER CONFEZ. PCS PER PACK.
92	0,50	6	500
92L/10	0,50	10	500
93C	0,75	6	500
93	0,75	8	500
93L	0,75	10	500
94C	1	6	500
94	1	8	500
95C	1,5	7	500
95	1,5	10	500
96C	2,5	7	500
96	2,5	10	500
97	4	9	500
97L	4	12	500
98	6	12	500
98L	6	15	500
99	10	12	500
99L	10	15	500
100	16	12	500
100L	16	15	500
100L/20	16	20	500
100L/25	16	25	500
101	25	15	500
102	35	18	500
102/12	35	12	500
103	50	18	500
104	70	25	100

# CAPICORDA NUDI 0,25÷6 mm<sup>2</sup>

## NON-INSULATED TERMINALS 0,25÷6 mm<sup>2</sup>



- MATERIALE**  
Rame elettrolitico 99,9 stagnato
- MATERIAL**  
99,9 tinned electrolytic copper

EAC CE

## CAPICORDA A OCCHIELLO / RING TERMINALS

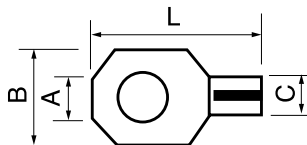

C140



C8G/L



C65-ASOLA



C5/DOPPIO



CSF/DOPPIO



ARTICOLO ARTICLE	SEZIONE WIRE RANGE mm <sup>2</sup>	AWG	Ø A FORO VITE SCREW HOLE	B	C	L	PEZZI PER CONFEZ. PCS PER PACK.	BLISTER con codice a barre with barcode
A2	0,25÷1,5	22÷16	2,4	5,7	1,8	12	1000	100
A3	0,25÷1,5	22÷16	3,6	5,7	1,8	12	1000	100
A4	0,25÷1,5	22÷16	4,2	6,9	1,8	14	1000	100
A5	0,25÷1,5	22÷16	5,4	8	1,8	15	1000	100
A6	0,25÷1,5	22÷16	6,2	10	1,8	19,3	1000	100
A8	0,25÷1,5	22÷16	8,2	12	1,8	19,3	1000	100
A10	0,25÷1,5	22÷16	10,2	13	1,8	22,4	1000	100
B3	1,5÷2,5	16÷14	3,6	6,4	2,4	15	1000	100
B4	1,5÷2,5	16÷14	4,2	6,4	2,4	15	1000	100
B5	1,5÷2,5	16÷14	5,2	8,5	2,4	17	1000	100
B6	1,5÷2,5	16÷14	6,2	9,4	2,4	18	1000	100
B8	1,5÷2,5	16÷14	8,2	13	2,4	22,5	1000	100
B10	1,5÷2,5	16÷14	10,2	13	2,4	22,5	1000	100
B12	1,5÷2,5	16÷14	12,2	18	2,4	29	1000	50
C3	2,5÷6	12÷10	3,6	6,9	3,6	19,2	1000	100
C4	2,5÷6	12÷10	4,2	8	3,6	19	1000	100
C5	2,5÷6	12÷10	5,2	10	3,6	19,6	1000	100
C6	2,5÷6	12÷10	6,2	10	3,6	19,6	1000	100
C8	2,5÷6	12÷10	8,2	14	3,6	24,3	1000	50
C10	2,5÷6	12÷10	10,2	14	3,6	24,3	1000	50
C12	2,5÷6	12÷10	12,2	18	3,6	30,5	1000	50
C140	2,5÷6	12÷10	14,2	24	3,6	35	500	50
C160	2,5÷6	12÷10	16,2	24	3,6	35	500	50

### PRODOTTI INNOVATIVI / INNOVATIVE PRODUCTS

C8G/L	2,5÷6	12÷10	8,2	15	3,6	25	500	100
C10G/L	2,5÷6	12÷10	10,2	15	3,6	25	500	100
C65-ASOLA	2,5÷6	12÷10	5 e 6	10,6	3,6	24,8	500	50
C-SF/DOPPIO	2,5÷6	12÷10	SF	10	3,6	42,6	500	100
C5/DOPPIO	2,5÷6	12÷10	5,2	10	3,6	42,6	500	100
C6/DOPPIO	2,5÷6	12÷10	6,2	10	3,6	42,6	500	100

### C8G/L e C10G/L

- Per interruttori con vite imperdibile: occhiello con gancio laterale, adatto a sezioni da 6 mm<sup>2</sup> vite 8 e 10 con zigrinatura antiscivolo. Soluzione intelligente che riduce i tempi di collegamento, garantendo un contatto migliore. Disponibili nudi e preisolati.
- For switches with screw with anti-leakage device: ring with lateral hook suitable for wire range 6 mm<sup>2</sup>, screw 8 and 10 with anti slip grooves. An intelligent solution that can reduce connection times and that can guarantee a better contact. Available pre-insulated and not insulated.

### C65-ASOLA

- Occhiello asolato sezione 6 mm<sup>2</sup> per vite da 5 e da 6. Alternativa che permette con un unico terminale di utilizzare connessioni con vite M5 e M6.
- Ring buttonhole, wire range 6 mm<sup>2</sup> for screw hole 5 and 6. It is an alternative solution which allows to use connections with screw M5 and M6 with a single terminal.

### C-SF/DOPPIO - C5/DOPPIO e C6/DOPPIO

- Giunto doppio per sezioni da 6 mm<sup>2</sup> con foro vite da 5 o 6 mm, oppure senza foro vite.
- Double butt-connector, wire range 6 mm<sup>2</sup> with screw hole 5 or 6mm or without hole.

### ART. 52

Pinza a cricchetto per capicorda nudi da 1,5 a 10 mm<sup>2</sup>  
Ratchet tool for non insulated terminals 1,5 to 10 mm<sup>2</sup>



### ART. 53

Pinza manuale per capicorda nudi e preisolati da 0,25 a 6 mm<sup>2</sup>  
Manual tool for insulated and non insulated terminals 0,25 to 6 mm<sup>2</sup>



# CAPICORDA NUDI 0,25÷6 mm<sup>2</sup> NON-INSULATED TERMINALS 0,25÷6 mm<sup>2</sup>



- MATERIALE**  
Rame elettrolitico 99,9 stagnato
- MATERIAL**  
99,9 tinned electrolytic copper

EAC CE

## CAPICORDA NUDI A FORCELLA CON ZIGRINATURA ANTI-SCIVOLO

La zigrinatura antiscivolo consente una migliore tenuta sulla vite, rendendo il prodotto più sicuro e più facile da utilizzare.

## NON INSULATED FORK TERMINALS WITH ANTI SLIP GROOVES

The anti slip grooves provide a better connection on the screw, increasing functionality and safety of the product.

## CAPICORDA A FORCELLA / FORK TERMINALS

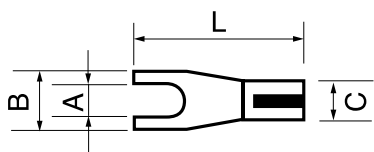

**B16L**



**B135L**



**C14S**



ARTICOLO ARTICLE	SEZIONE WIRE RANGE mm <sup>2</sup>	AWG	Ø A FORO VITE SCREW HOLE	B	C	L	PEZZI PER CONFEZ. PCS PER PACK.	BLISTER con codice a barre with barcode
<b>A13</b>	0,25÷1,5	22÷16	3	5	1,8	13,7	1000	100
<b>A135</b>	0,25÷1,5	22÷16	3,6	5,9	1,8	12,2	1000	100
<b>A135S</b>	0,25÷1,5	22÷16	3,6	6,5	1,8	14,5	1000	100
<b>A14</b>	0,25÷1,5	22÷16	4,1	6,5	1,8	14	1000	100
<b>A15</b>	0,25÷1,5	22÷16	5,2	8,5	1,8	15,3	1000	100
<b>A16</b>	0,25÷1,5	22÷16	6,2	10,5	1,8	15,3	1000	100
<b>A18</b>	0,25÷1,5	22÷16	8,2	12	1,8	21	1000	100
<b>B13</b>	1,5÷2,5	16÷14	3	5,5	2,4	15,5	1000	100
<b>B135</b>	1,5÷2,5	16÷14	3,5	6,4	2,4	15	1000	100
<b>B135L</b>	1,5÷2,5	16÷14	3,5	6,3	2,4	18	1000	100
<b>B14</b>	1,5÷2,5	16÷14	4,1	6,5	2,4	15	1000	100
<b>B14L</b>	1,5÷2,5	16÷14	4,1	6,5	2,4	16	1000	100
cava lunga per ponte <b>B14S</b> con blocco	1,5÷2,5	16÷14	4,1	6,4	2,4	15	1000	100
<b>B15</b>	1,5÷2,5	16÷14	5,2	9	2,4	16,3	1000	100
<b>B16</b>	1,5÷2,5	16÷14	6,2	10,5	2,4	18,3	1000	100
cava lunga per ponte <b>B16L</b>	1,5÷2,5	16÷14	6,2	10,5	2,4	18,3	1000	100
<b>B18</b>	1,5÷2,5	16÷14	8,2	12	2,4	21	1000	100
<b>B110</b>	1,5÷2,5	16÷14	10,2	13,5	2,4	22	1000	100
<b>B112</b>	1,5÷2,5	16÷14	12,2	18	2,4	29	1000	100
<b>C13</b>	2,5÷6	12÷10	3,5	6,9	3,6	19,4	1000	100
<b>C14</b>	2,5÷6	12÷10	4,3	8	3,6	19	1000	100
<b>C14S</b> con blocco	2,5÷6	12÷10	4,1	8	3,6	18	1000	100
<b>C15</b>	2,5÷6	12÷10	5,2	10,5	3,6	21	1000	100
<b>C16</b>	2,5÷6	12÷10	6,4	11,5	3,6	21	1000	100
<b>C18</b>	2,5÷6	12÷10	8,5	13	3,6	24	1000	100
<b>C110</b>	2,5÷6	12÷10	10,5	15	3,6	24,5	1000	50
<b>C112</b>	2,5÷6	12÷10	12,2	18	3,6	30,5	1000	50
<b>D13//NA</b>	6÷10	8	3,6	6,9	3,6	19,4	1000	



# CAPICORDA NUDI 0,25÷6 mm<sup>2</sup>

## NON-INSULATED TERMINALS 0,25÷6 mm<sup>2</sup>



- MATERIALE**  
Rame elettrolitico 99,9 stagnato
- MATERIAL**  
99,9 tinned electrolytic copper

EAC CE

### PUNTALE ROTONDO / ROUND PIN TERMINAL

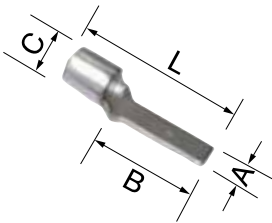

ARTICOLO ARTICLE	SEZIONE WIRE RANGE mm <sup>2</sup>	AWG	A	B	C	L	PEZZI PER CONFEZ. PCS PER PACK.	BLISTER con codice a barre with barcode
A1C	0,25÷1,5	22÷16	1,7	9	1,8	12	1000	100
A1	0,25÷1,5	22÷16	1,7	11	1,8	16	1000	100
B1C	1,5÷2,5	16÷14	1,8	9	2,3	15	1000	100
B1	1,5÷2,5	16÷14	1,8	11	2,3	17	1000	100
C1	2,5÷6	12÷10	2,6	13	3,6	20	1000	100

### PUNTALE PIATTO / FLAT PIN TERMINAL

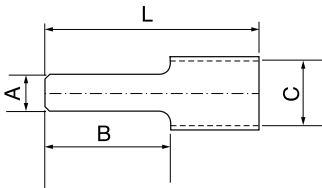

ARTICOLO ARTICLE	SEZIONE WIRE RANGE mm <sup>2</sup>	AWG	A	B	C	L	PEZZI PER CONFEZ. PCS PER PACK.	BLISTER con codice a barre with barcode
A11C	0,25÷1,5	22÷16	3	9	1,8	14	1000	100
A11	0,25÷1,5	22÷16	3	11,5	1,8	16,5	1000	100
A11L	0,25÷1,5	22÷16	2,5	17	1,8	21,7	1000	100
B11	1,5÷2,5	16÷14	3	12	2,3	17,3	1000	100
B11L	1,5÷2,5	16÷14	2,5	17	2,3	21,7	1000	100
C11	2,5÷6	12÷10	4	13,8	3,6	21,7	1000	100
C11C	2,5÷6	12÷10	4	9	3,6	17	1000	100

# PUNTALINI DI POTENZA 10-95 mm<sup>2</sup>

## POWER PIN 10-95 mm<sup>2</sup>



- MATERIALE**  
Tubo rame stagnato  
CON ZIGRINATURA ANTISCIVOLO
- MATERIAL**  
Tinned copper tube  
WITH ANTI SLIP GROOVES

EAC CE

- Per isolare i puntalini di potenza è possibile utilizzare i cappucci tipo P, disponibili nel colore standard nero, oppure in diverse colorazioni.
- Utilizzare i cappucci declassando la sezione come in tabella.
- Su richiesta, possibilità di variare la lunghezza dei puntalini di piegarli a 90°.

- To insulate power pins it is possible to use soft sleeves type P, available in the standard black colour, or in several different colours.
- Use soft sleeves declassing wire range as shown in tab.
- On request it is possible to change power pin length or to bent them to 90°.

Per un corretto uso delle pinze declassare la portata delle stesse di almeno una posizione. Esempio: 10mm<sup>2</sup>=6mm<sup>2</sup>.

For a correct use of crimping tools, declass wire range of the die by at least one position. For example: 10mm<sup>2</sup>=6mm<sup>2</sup>.

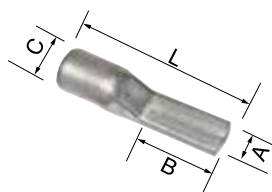

ARTICOLO ARTICLE	SEZIONE WIRE RANGE mm <sup>2</sup>	A	B	C	L	PEZZI PER CONFEZ. PCS PER PACK.	CAPPUCCI ISOLANTI DECLASSATI
D1	10	4,3	12	4,6	25	100	PC
E1	16	6	14,5	6	29	100	PD
F1	25	7	15,5	6,6	34,5	100	PE
G1	35	9	19	9	42	100	PF
H1	50	10	20,5	10	46,5	50	PG
I1	70	12	23,5	12	55,5	50	PH
L1	95	13	25	13	58	50	PI

# CAPICORDA NUDI A INNESTO RAPIDO 0,25÷6 mm<sup>2</sup> NON-INSULATED QUICK CONNECT TERMINALS 0,25÷6 mm<sup>2</sup>

- MATERIALE**  
Ottone OT 67 grezzo  
A RICHIESTA DISPONIBILI ANCHE STAGNATI
- MATERIAL**  
OT 67 not tinned brass  
ON REQUEST AVAILABLE TINNED

EAC CE

## CAPICORDA A INNESTO RAPIDO APERTI / OPEN QUICK CONNECT TERMINALS

ARTICOLO ARTICLE	SEZIONE WIRE RANGE mm <sup>2</sup>	AWG		LINGUETTA TONGUE	L	PEZZI PER CONFEZ. PCS PER PACK.	BLISTER con codice a barre with barcode	
<b>B22S-A</b>								
<b>A42-A</b>								
<b>A00-A</b>								
<b>B02-A</b>								
<b>A04-A</b>								
<b>B22-A</b>								
<b>B30-A</b>								
<b>C09-A</b>								
<b>A01-A</b>								
<b>B02-A/BAND</b>								
<b>0010</b>								
<b>B02-A/D</b>								
<b>A04-A</b>	0,25÷1,5	22÷16		2,8x0,5	14	1000	100	FEMMINA FEMALE
<b>A04-A/D</b>	0,25÷1,5	22÷16		2,8x0,5	14	1000	100	
<b>A00-A</b>	0,25÷1,5	22÷16		2,8x0,8	14	1000	100	
<b>A01-A</b>	0,25÷1,5	22÷16		4,8x0,8	15	1000	100	
<b>A02-A</b>	0,25÷1,5	22÷16		6,3x0,8	19	1000	100	
<b>A05-A</b>	0,25÷1,5	22÷16		4,8x0,5	15	1000	100	
<b>B02-A</b>	0,50÷2,5	16÷14		6,3x0,8	19	1000	100	
<b>B02-A/D</b>	0,50÷2,5	16÷14	con dentino	6,3x0,8	19	1000	100	
<b>B02-A/B</b>	0,50÷2,5	16÷14	con blocco	6,3x0,8	19	1000	100	
<b>B02-A/BAND</b>	0,50÷2,5	16÷14	90°	6,3x0,8	16	1000	100	
<b>C09-A</b>	2,5÷6	12÷10		9,9x1	25	1000	50	
<b>B30-A</b>	0,50÷2,5	16÷14	raccordo misto	6,3x0,8	21	1000	50	MASCHIO +FEMMINA MALE +FEMALE
<b>0010</b>	DOPPIO INNESTO (TIPO30)			6,3x0,8	19	1000	1000	
<b>A42-A</b>	0,50÷2	22÷16		2,8x0,5	15	1000	100	MASCHIO MALE
<b>B22-A</b>	1÷2,5	16÷14		6,3x0,8	20,7	1000	100	
<b>B22S-A</b>	1÷2,5	16÷14		6,3x0,8	29	1000	100	

## PINZE PER CAPICORDA APERTI / TOOLS FOR OPEN TERMINALS

### ART. 50

Pinza per capicorda aperti da 0,25 a 6 mm<sup>2</sup>.  
Taglia e spella fili.  
Tool for open terminals from 0,25 to 6 mm<sup>2</sup>.  
Cut and wire stripper.



### ART. 51R

Pinza a cricchetto per capicorda aperti da 0,5 a 2,5 mm<sup>2</sup>.  
Ratchet tool for open terminals from 0,5 to 2,5 mm<sup>2</sup>



### ART. 51

Pinza a cricchetto per capicorda aperti da 0,5 a 6 mm<sup>2</sup>.  
Ratchet tool for open terminals from 0,5 to 6 mm<sup>2</sup>



### ART. 51B

Pinza manuale per capicorda aperti da 0,25 a 6 mm<sup>2</sup>.  
Manual tool for open terminals from 0,25 to 6 mm<sup>2</sup>



# CAPICORDA NUDI A INNESTO RAPIDO 0,25÷6 mm<sup>2</sup> NON-INSULATED QUICK CONNECT TERMINALS 0,25÷6 mm<sup>2</sup>

## MATERIALE

Ottone OT 67 grezzo

A RICHIESTA DISPONIBILI ANCHE STAGNATI

## MATERIAL

OT 67 not tinned brass

ON REQUEST AVAILABLE TINNED

## SPINA CILINDRICA APERTA / OPEN SOCKET

ARTICOLO ARTICLE	SEZIONE WIRE RANGE mm <sup>2</sup>	AWG	Ø A	LUNGHEZZA LENGTH	PEZZI PER CONFEZ. PCS PER PACK.	BLISTER con codice a barre with barcode	
B69-A	0,50÷2,5	16÷14	4	21	1000	100	FEMMINA FEMALE
B96-A	0,50÷2,5	16÷14	4	25	1000	100	MASCHIO MALE

## OCCHIELLI APERTI / OPEN RINGS

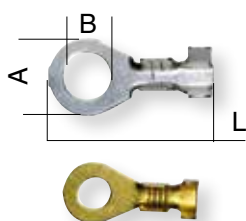

ARTICOLO ARTICLE	SEZIONE WIRE RANGE mm <sup>2</sup>	AWG	Ø A	Ø A FORO VITE SCREW HOLE	L	PEZZI PER CONFEZ. PCS PER PACK.	BLISTER con codice a barre with barcode
A4-A	0,50÷2	22÷16	8,7	4,2	19	1000	100
A5-A	0,50÷2	22÷16	8,7	5,2	20	1000	100
A6-A	0,50÷2	22÷16	8,7	6,2	20	1000	100
B5-A	0,50÷2,5	16÷14	8,7	5,2	20	1000	100
D5-A	6÷10	8	10	5,2	24	500	50

A richiesta disponibili in bobina o stagnati / On request available in reel or tinned

## CAPICORDA A INNESTO RAPIDO PRE-CHIUSI FEMMINA / FEMALE PRE-CLOSED QUICK CONNECT TERMINALS

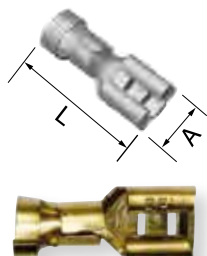

ARTICOLO ARTICLE	SEZIONE WIRE RANGE mm <sup>2</sup>	AWG	A	L	PEZZI PER CONFEZ. PCS PER PACK.	BLISTER con codice a barre with barcode
B02L	1÷2,5	16÷14	6,3x0,8	20	1000	100
C02L	2,5÷6	12÷10	6,3x0,8	20	1000	100

A richiesta disponibili stagnati / On request available tinned

## CAPICORDA IN ACCIAIO NICHELATO ADATTI ALLE ALTE TEMPERATURE / NIKEL STEEL TERMINALS SUITABLE FOR HIGH TEMPERATURE

B02-A-A

B30-A-A



B4-A-A

C6-A-A



ARTICOLO ARTICLE	SEZIONE WIRE RANGE mm <sup>2</sup>	VITE SCREW	L	PEZZI PER CONFEZ. PCS PER PACK.
B02-A-A	1÷2,5	6,3x0,8	18,5	100
B30-A-A	1÷2,5	6,3x0,8	20	100
B4-A-A	1÷2,5	M4	19,3	100
B5-A-A	1÷2,5	M5	19,3	100
B6-A-A	1÷2,5	M6	19,3	100
C4-A-A	4÷6	M4	23,5	100
C5-A-A	4÷6	M5	23,5	100
C6-A-A	4÷6	M6	23,5	100

# CAPICORDA NUDI A INNESTO RAPIDO 0,25÷6 mm<sup>2</sup>

## NON-INSULATED QUICK CONNECT TERMINALS 0,25÷6 mm<sup>2</sup>



**MATERIALE**  
Ottone OT 67 stagnato

**MATERIAL**  
OT 67 tinned brass

**EAC CE**

## CAPICORDA A INNESTO RAPIDO CHIUSI FEMMINA / CLOSED FEMALE QUICK CONNECT TERMINALS

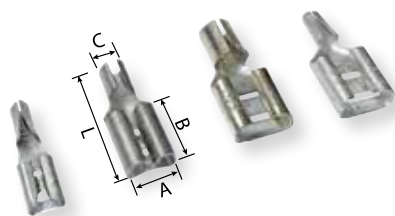

ARTICOLO ARTICLE	SEZIONE WIRE RANGE mm <sup>2</sup>	AWG	A	B	C	L	PEZZI PER CONFEZ. PCS PER PACK.	BLISTER con codice a barre with barcode
A00	0,25÷1,5	22÷16	2,8x0,8	6	1,8	14,5	1000	100
A01	0,25÷1,5	22÷16	4,8x0,8	6	1,8	13	1000	100
A02	0,25÷1,5	22÷16	6,3x0,8	7,8	1,8	16	1000	100
A03	0,25÷1,5	22÷16	5,2x0,8	7,8	1,8	15	1000	100
A04	0,25÷1,5	22÷16	2,8x0,5	6	1,8	14,5	1000	100
A05	0,25÷1,5	22÷16	4,8x0,5	6	1,8	13	1000	100
B00	1,5÷2,5	16÷14	2,8x0,8	6	2,3	14,5	1000	100
B01	1,5÷2,5	16÷14	4,8x0,8	6	2,3	13	1000	100
B02	1,5÷2,5	16÷14	6,3x0,8	7,8	2,3	16	1000	100
B03	1,5÷2,5	16÷14	5,2x0,8	7,8	2,3	15	1000	100
B04	1,5÷2,5	16÷14	2,8x0,5	6	2,3	14,5	1000	100
B05	1,5÷2,5	16÷14	4,8x0,5	6	2,3	13	1000	100
C01	2,5÷6	12÷10	4,8x0,8	6	3,4	13	1000	100
C02	2,5÷6	12÷10	6,3x0,8	7,8	3,4	16	1000	100

## CAPICORDA A INNESTO RAPIDO CHIUSI MASCHIO / CLOSED MALE QUICK CONNECT TERMINALS

**MATERIALE**  
Rame elettrolitico  
99,9 stagnato

**MATERIAL**  
99,9 tinned electrolytic  
copper

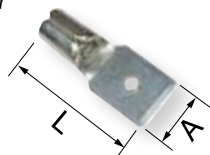

ARTICOLO ARTICLE	SEZIONE WIRE RANGE mm <sup>2</sup>	AWG	A	L	PEZZI PER CONFEZ. PCS PER PACK.	BLISTER con codice a barre with barcode
A11C	0,25÷1,5	22÷16	2,8x0,7	14	1000	100
A22	0,25÷1,5	22÷16	6,3x0,8	15,8	1000	100
A32	0,25÷1,5	22÷16	4,8x0,8	13,6	1000	100
B22	1,5÷2,5	16÷14	6,3x0,8	16,6	1000	100
B32	1,5÷2,5	16÷14	4,8x0,8	13,5	1000	100
B35	1,5÷2,5	16÷14	4,8x0,5	13,5	1000	100
C22	2,5÷6	12÷10	6,3x0,8	16,5	1000	100
C29	2,5÷6	12÷10	9,9x1	19,5	1000	100

# PRESE LAMELLARI MASCHIO IN OTTONE

## QUICK CONNECT MALE BRASS TABS

—● **MATERIALE**  
Ottone OT 67 grezzo

—● **MATERIAL**  
OT 67 not tinned brass

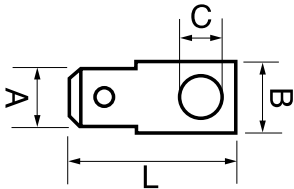

ARTICOLO ARTICLE	A	B	C	L	PEZZI PER CONFEZ. PCS PER PACK.
1) 002 DRITTA	6,3x0,8	8,2	3-4-5-6	19	2500
2) 004 A 90°	6,3x0,8	8,2	3-4-5-6	19	2500
3) 005 A 45°	6,3x0,8	8,2	3-4-5-6	19	2500
4) 006 A 45°	6,3x0,8	15	6-8-10	35	2500
5) 007 DOPPIA DRITTA	6,3x0,8	8,2	3-4-5-6	30,6	2500
6) 008 A 45° DOPPIA	6,3x0,8	8,2	3-4-5-6	30,6	2500
7) 009 A 90° DOPPIA	6,3x0,8	8,2	3-4-5-6	30,6	2500

A richiesta disponibili stagnati / On request available tinned

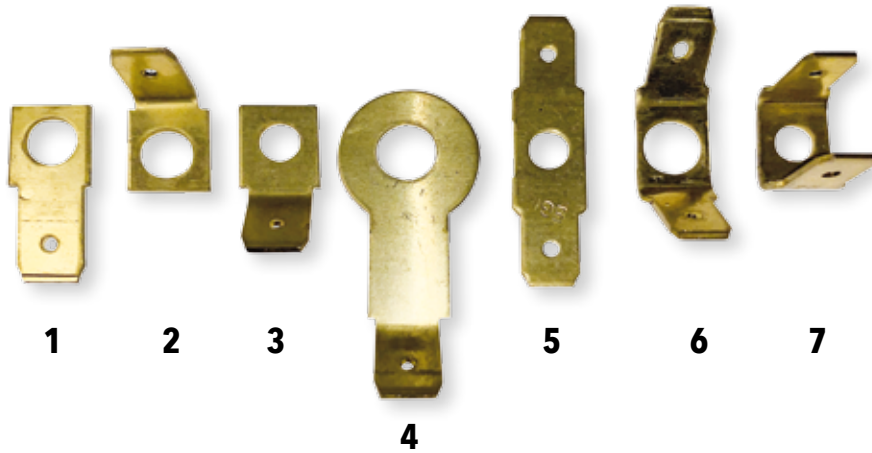

## LAMELLE SPECIALI IN OTTONE STAGNATO / SPECIAL TINNED BRASS TABS



—● **MATERIALE**  
Ottone OT 67 stagnato

—● **MATERIAL**  
OT 67 tinned brass

ARTICOLO ARTICLE	A	B	L	PEZZI PER CONFEZ. PCS PER PACK.
1) 001 A SALDARE PER CIRCUITO STAMPATO	6,3x0,8	8,2	14	1000
2) 002/G CON DENTINO	6,3x0,8	8,2	19	1000
3) 005/4 SPEC VITE 4	6,3x0,8	7	17	1000

# CAPPUCCI ISOLANTI PER CAPICORDA A INNESTO RAPIDO

## INSULATING CAPS FOR RAPID CONNECTORS

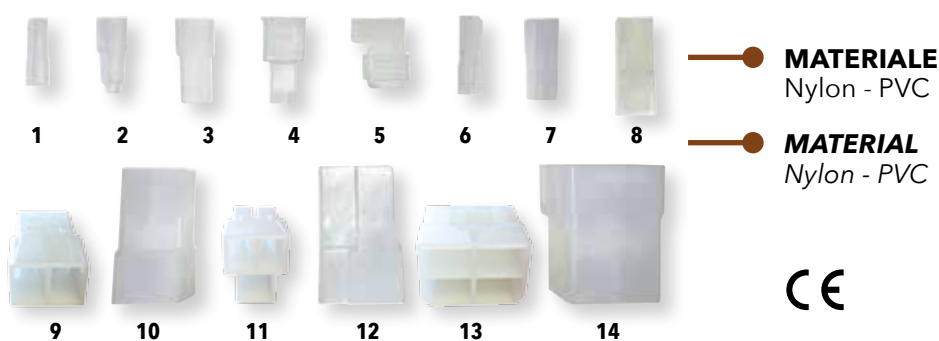

### CAPPUCCI / SLEEVES

ARTICOLO ARTICLE	PER CAPICORDA FOR TERMINALS	PEZZI PER CONFEZ. PCS PER PACK.
1) ART.00 FEMMINA	2,8	1000
2) ART.01 FEMMINA	4,8	1000
3) ART.02 FEMMINA	6,3	1000
4) ART.22 MASCHIO	6,3	1000
5) ART.02 BANDIERA	6,3	1000
6) ART.00/T CON BLOCCO FRONTALE	2,8	1000
7) ART.01/T CON BLOCCO FRONTALE	4,8	1000
8) ART.02/T CON BLOCCO FRONTALE	6,3	1000
9) ART.630 PORTA FEMMINA 2 VIE	6,3	100
10) ART.631 PORTA MASCHIO 2 VIE	6,3	100
11) ART.ECT 1030 PORTA FEMMINE 3 VIE	6,3	100
12) ART.ECT 1031 PORTA MASCHIO 3 VIE	6,3	100
13) ART.ECT 1040 PORTA FEMMINE 4 VIE	6,3	100
14) ART.ECT 1041 PORTA MASCHIO 4 VIE	6,3	100

### CONNETTORI DI CODA / END CONNECTORS

UL APPROVED



C US



ARTICOLO ARTICLE	SEZIONE WIRE RANGE mm <sup>2</sup>	AWG	LUNGHEZZA LENGTH	PEZZI PER CONFEZ. PCS PER PACK.
A-CODA	0,25÷1,5	22÷16	20	1000
B-CODA	1,5÷2,5	16÷14	20	1000
C-CODA	2,5÷6	12÷10	25,5	500
D-CODA	6÷10	8÷10	27,6	500

### CONNETTORI RAPIDI (MORSETTO AUTOSPELLANTE) / RAPID CONNECTORS

UL

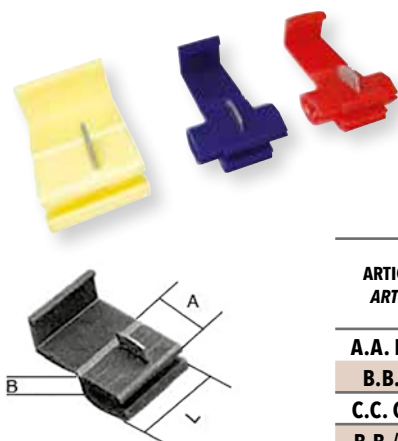

**MATERIALE** Isolante (PP) in Polipropilene  
**TENSIONE NOMINALE** 380v  
**TEMPERATURA D'ESERCIZIO** 90°C

**MATERIAL** Polypropylene insulating (PP)  
**TENSION** 380v  
**TEMPERATURE** 90°C

ARTICOLO ARTICLE	SEZIONE WIRE RANGE mm <sup>2</sup>	AWG	A	B	L	PEZZI PER CONFEZ. PCS PER PACK.
A.A. Rosso	0,25÷1,5	22÷16	13,5	10	19,5	100
B.B. Blu	1,5÷2,5	16÷14	13,5	10	19,5	100
C.C. Giallo	2,5÷6	12÷10	15	10	20	100
B.B./S Blu	1,25÷2,5	16÷14	18	11	9,5	100

A richiesta disponibili anche in nylon / On request available in nylon



**EGI**<sup>®</sup>  
S.r.l.



## PRODUZIONE SPECIALI SPECIAL PRODUCTION

Oltre agli articoli standard, EGI è in grado di realizzare, in tempi brevi e con costi contenuti, **prodotti speciali su richiesta di ogni singolo cliente**, atti a risolvere qualsiasi esigenza di connessione elettrica.

Inoltre, sono sempre allo studio e alla progettazione articoli nuovi e altamente innovativi che periodicamente vanno ad ampliare la già vasta gamma di prodotti a catalogo.

La possibilità di fornire ARTICOLI STANDARD, ARTICOLI SPECIALI SU RICHIESTA E ARTICOLI INNOVATIVI, rendono EGI unica nel settore elettrico, sempre all'avanguardia e in continua evoluzione!

*In addition to standard items, EGI is able to produce, with short delivery times and with low costs, **special products on request of each single customer**, to face and solve every electric connection needs. Furthermore, EGI is always work in progress with study and design of new highly innovative items which periodically expand the already large range of products in catalogue.*

*The ability to supply STANDARD ITEMS, SPECIAL ITEMS ON REQUEST AND INNOVATIVE ITEMS, make EGI unique in the electric field, always at cutting edge and in constant evolution!*



LA GAMMA AGGIORNATA DEI PRODOTTI EGI E' CONSULTABILE ALL'INDIRIZZO  
THE UPDATED EGI RANGE OF PRODUCTS IS AVAILABLE AT THE ADDRESS

[www.egisrl.it](http://www.egisrl.it)

EGI SRL - Via Gobetti, 44 - 20072 Fizzonasco di Pieve Emanuele (MI)  
Tel. 02/90.72.19.44 - Fax 02/90.72.46.46 - e-mail: [info@egisrl.it](mailto:info@egisrl.it) - [www.egisrl.it](http://www.egisrl.it)

# GIUNTI DI POTENZA POWER BUTT-CONNECTORS



**MATERIALE**  
Tubo rame stagnato

**MATERIAL**  
Tinned copper tube

**EAC CE**

## CONNETTORI DI TESTA / BUTT CONNECTORS

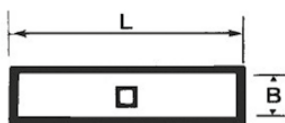

I giunti sono ricavati da tubo rame avente le stesse dimensioni usate per i capicorda di potenza e sono dotati di smusso ad entrambe le estremità per facilitare l'ingresso del cavo.

*Butt-connectors are made with same copper tube used for power terminals and they have smoothed on both end sides for an easy cable entry.*

ARTICOLO ARTICLE	SEZIONE WIRE RANGE mm <sup>2</sup>	L	B	PEZZI PER CONFEZ. PCS PER PACK.	
A20	1,5	15	2	100/1000	STANDARD CON FORO ISPEZIONE A RICHIESTA SENZA FORO STANDARD WITH INSPECTION HOLE ON REQUEST WITHOUT HOLE
B20	2,5	15	2,7	100/1000	
C20	6	21	3,7	100/1000	
D20	10	25	4,6	100	
E20	16	27	6	100	
F20	25	29	7	100	
G20	35	36	9	100	
H20	50	37	10	100	
I20	70	39	12	50	
L20	95	43	13,7	25	
M20	120	47	15,2	25	STANDARD SENZA FORO ISPEZIONE STANDARD WITHOUT INSPECTION HOLE
N20	150	58	16,7	20	
O20	185	64	19,2	10	
P20	240	75	21,5	10	
Q20	300	90	23,7	10	
R20	400	94	27	5	
S20	500	98	30,3	5	
T20	630	105	33,4	5	
U20	800	112	38	3	
V20	1.000	120	44	3	

A richiesta possibilità di realizzare lunghezze diverse da quelle standard / On request possibility to produce different length from standard ones

## CONNETTORI PARALLELI / PARALLEL CONNECTORS



ARTICOLO ARTICLE	SEZIONE WIRE RANGE mm <sup>2</sup>	L	B	PEZZI PER CONFEZ. PCS PER PACK.
A20C	1,5	6	2	1000
B20C	2,5	6	2,7	1000
C20C	6	9	3,7	1000
D20C	10	12	4,6	500
E20C	16	12	6	500
F20C	25	13	7	500
G20C	35	14	9	200
H20C	50	16	10	100
I20C	70	18	12	100
L20C	95	19	13,7	50
M20C	120	22	15,2	50
N20C	150	26,5	16,7	50
O20C	185	26,5	19,2	50
P20C	240	34	21,5	50
Q20C	300	43	23,7	25



## PINZE / TOOLS



### —● ART. 55

- Pinza idraulica manuale per la compressione di capicorda, connettori e giunti a C per sezioni da 6 a 240 mm<sup>2</sup> (fornita senza matrici).
  - Costruzione leggera e compatta con testa di compressione a scatto ruotabile di 180°.
  - Dispositivo automatico per l'avanzamento a 2 velocità.
  - Limitatore di pressione automatico.
  - Ritorno manuale in qualsiasi posizione mediante rotazione dell'impugnatura principale.
- *Manual hydraulic tool to crimp terminals, butt connectors and "C" connectors for wire range from 6 up to 240 mm<sup>2</sup> (supplied without dies).*
  - *Light and compact tool with automatic release compression head turning to 180°.*
  - *Automatic tool with dual speed.*
  - *Automatic pressure controller.*
  - *Manual reset in any position by rotation of the main hand.*

**FORZA DI COMPRESSIONE:** 50 kN  
**PRESSIONE D'ESERCIZIO:** 520 BAR  
**DIMENSIONI:** 460x240x90 mm  
**PESO:** 3,7 KG

**COMPRESSION STRENGTH:** 50 kN  
**PRESSURE:** 520 BAR  
**DIMENSIONS:** 460x240x90 mm  
**WEIGHT:** 3,7 KG



RAME



ALLUMINIO



ACCIAIO



GIUNTI A "C"

## MATRICI PER PINZA ART. 55 E ART. 55BAT / DIES FOR TOOL ART. 55 AND ART. 55BAT

SEZIONI MM <sup>2</sup>												
TIPO MATRICE	6	10	16	25	35	50	70	95	120	150	185	240
ESAGONALE CAPICORDA IN RAME		M3/5510E	M3/5516E	M3/5525E	M3/5535E	M3/5550E	M3/5570E	M3/5595E	M3/55120E	M3/55150E	M3/55185E	M3/55240E
ESAGONALE CAPICORDA IN ALLUMINIO			M4/551635A			M4/555095A			M4/55120150A			
A SPINA CAPICORDA IN ACCIAIO			M5/5516AC	M5/5525AC	M5/5535AC	M5/5550AC	M5/5570AC	M5/5595AC				
GIUNTI A "C"	M2/556	M2/5510	M2/551625		M2/5535	M2/555070						

## PINZE / TOOLS



### ART. 58

- Pinza idraulica manuale per la compressione di capicorda, connettori e giunti a "C" per sezioni da 10 a 300/400 mm<sup>2</sup> (fornita senza matrici).
- Dotata di dispositivo automatico per l'avanzamento a 2 velocità e azionabile con una mano sola nella fase di avanzamento veloce grazie alla maniglia incorporata nel manico mobile.
- Limitatore di pressione automatico.
- *Manual hydraulic tool to clamp terminals, butt connectors and "C" connectors for wire range from 10 up to 300/400 mm<sup>2</sup>, (supplied without dies).*
- *It has an automatic mechanism dual speed operating with only one hand during the high speed phase thanks to the handle attached to mobile grip.*
- *Automatic pressure limiter.*

**FORZA DI COMPRESSIONE:** 130 kN  
**PRESSIONE D'ESERCIZIO:** 700 BAR  
**APERTURA TESTA:** 29 mm  
**DIMENSIONI:** 705x270x100 mm  
**PESO:** 8,2 KG

**COMPRESSION STRENGTH:** 130 kN  
**PRESSURE:** 700 BAR  
**HEAD OPENING:** 29 mm  
**DIMENSIONS:** 705x270x100 mm  
**WEIGHT:** 38,2 KG



RAME



ALLUMINIO



ACCIAIO



GIUNTI A "C"

## MATRICI E PUNZONI PER PINZA ART. 58 / DIES AND PUNCH FOR TOOL ART. 58

		SEZIONI MM <sup>2</sup>													
TIPO DI AGGRAFFATURA		10	16	25	35	50	70	95	120	150	185	240	300	400	
A PUNZONE	PUNZONE	P58/1050					P58/7095		P58/120300						
	MATRICE	M1/5810	M1/5816	M1/5825	M1/5835	M1/5850	M1/5870	M1/5895	M1/58120	M1/58150	M1/58185	M1/58240	M1/58300		
ESAGONALE CAPICORDA IN RAME		M3/5810E	M3/5816E	M3/5825E	M3/5835E	M3/5850E	M3/5870E	M3/5895E	M3/58120E	M3/58150E	M3/58185E	M3/58240E	M3/58300E	M3/58400E	
ESAGONALE CAPICORDA IN ALLUMINIO			M4/581635A			M4/585095A			M4/58120150A		M4/58185240A				
A SPINA CAPICORDA IN ACCIAIO			M5/5816AC	M5/5825AC	M5/5835AC	M5/5850AC	M5/5870AC	M5/5895AC	M5/58120AC						
GIUNTI A "C"		M2/58610	M2/581625		M2/5835	M2/585070		M2/5895	M2/58120185						

# PINZE / TOOLS

## ART. 59

- Pompa oleodinamica a pedale completa di testa adatta per sezioni da 10 a 630 mm<sup>2</sup>.
- Dispone di due velocità di mandata: una di avvicinamento e una di lavoro ed è in grado di sviluppare una pressione di esercizio di 700bar.
- Dotata di valvola a scatto che nell'uso dei cilindri aggraffatori assicura la perfetta esecuzione del lavoro garantendo l'uniformità del serraggio.
- Fornita completa di tubo per alta pressione lungo 2 metri con innesto rapido oleodinamico.
- Hydraulic foot pump with head included, suitable for wire range from 10 up to 630 mm<sup>2</sup>.
- It is dual speed and it can develop 700bar pressure.
- It is equipped with a release valve which, in conjunction with seaming cylinders ensures the perfect completion of the job, guaranteeing the crimping uniformity.
- It is supplied with two meter long high pressure tube with rapid hydraulic coupling.



**FORZA DI COMPRESSIONE:** 55 kN  
**PRESSIONE D'ESERCIZIO:** 700 BAR  
**DIMENSIONI:** 425x130x320 mm  
**PESO:** 6 KG

**COMPRESSION STRENGTH:** 55 kN  
**PRESSURE:** 700 BAR  
**DIMENSIONS:** 425x130x320 mm  
**WEIGHT:** 6 KG

## MATRICI PER PINZA ART. 59 / DIES FOR TOOL ART. 59

		SEZIONI MM <sup>2</sup>															
TIPO DI AGGRAFFATURA		10	16	25	35	50	70	95	120	150	185	240	300	400	500	630	
A PUNZONE	PUNZONE	P59/10200											P59/240500			P59/630	
	MATRICE	M1/591025			M1/593595				M1/59120160		M1/59185240		M1/59300	Sopra i 300 mm <sup>2</sup> non sono utilizzate matrici, i capicorda vanno inseriti direttamente nell'alloggiamento riservato alle matrici			
GIUNTI A "C"	MATRICE	M2/591625		M2/5935	M2/595070		M2/5995120										

## ART. 55BAT

- Pinza oleodinamica a batteria per la compressione di capicorda, connettori e giunti a "C" per sezioni da 6 a 240 mm<sup>2</sup> (fornita senza matrici).
- Costruzione leggera, robusta e compatta con testa per la compressione a scatto ruotabile di 360°.
- Avanzamento estremamente rapido mediante doppio pistone idraulico.
- Impugnatura girevole per una presa comoda e sicura.
- Controllo costante dello stato di carica della batteria tramite LED.
- LED multifunzione per:
  - controllo svolgimento operazioni e messaggi per: verde=OK; arancione=manutenzione; rosso=guasto;
  - controllo e visualizzazione del successivo intervallo di manutenzione;
  - messaggio in caso di eventuali guasti (sovraccarico, sovracorrente, temperatura eccessiva...).
- Battery hydraulic tool to clamp terminals, butt connectors and "C" connectors for wire range from 6 up to 240 mm<sup>2</sup>. (supplied without dies).
- Light, strong and compact tool with automatic release compression head rolling to 360°.
- High speed with dual hydraulic piston.
- Twisting grip for better control and more safety.
- Constant battery charge monitored by LED
- Multifunction LED for:
  - operation control and messages for: green=OK; orange=maintenance; red=out of order;
  - control and display of the next scheduled maintenance;
  - message of possible break down (overloaded, high temperature...).



**FORZA DI COMPRESSIONE:** 60 kN  
**DIMENSIONI:** 610x400x140 mm  
**PESO:** 6 KG

**COMPRESSION STRENGTH:** 60 kN  
**DIMENSIONS:** 610x400x140 mm  
**WEIGHT:** 6 KG



# EGI<sup>®</sup>

S.r.l.



## CAPPUCCI ISOLANTI TIPO P PER CAPICORDA DI POTENZA SOFT SLEEVES TYPE P FOR POWER TERMINALS

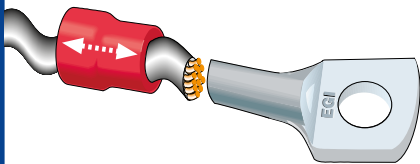

1

### INSERIRE IL CAPPUCCIO NEL CAVO

dal lato maggiore o minore a seconda del tipo di cavo utilizzato, rigido o flessibile e a seconda dell'isolamento che si vuole ottenere.

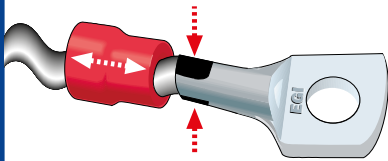

2

### PINZARE IL CAVO AL CAPICORDA

con crimpatura a punzone o esagonale e controllare il risultato ottenuto

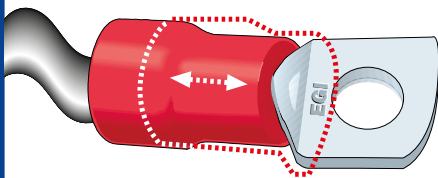

3

### PER OTTENERE UNA COPERTURA TOTALE

far scorrere il cappuccio sul terminale così da coprire la parte agganciata e ottenere un "isolamento totale" evitando inoltre l'eventuale rottura dell'isolante (inconveniente che può verificarsi a capicorda agganciati a basse temperature o con utensili non adatti)



### TO OBTAIN TOTAL COVERAGE

slide the sleeve over the terminal until it covers the crimped part and obtain total insulation (inconvenient which can occur to terminals crimped at low temperature or using tools not suitable)

#### VANTAGGI

- Il cappuccio tipo **P** si utilizza **a freddo** (non è termorestringente).
- Essendo un articolo complementare, non è necessario avere in magazzino la **doppia serie di terminali** nudi e preisolati (con relative pinze per nudi e pinze per preisolati).
- Una volta avvitata la connessione all'interruttore ipotetico vi è la possibilità di ottenere un **isolamento totale** semplicemente facendo scorrere il cappuccio mobile fino al fermo (grosso vantaggio se si pensa ai rischi di un eventuale cortocircuito nella parte scoperta negli altri tipi di isolamento).
- Abitualmente fornito di colore nero, il **cappuccio tipo P** è anche disponibile in altre **9 diverse colorazioni** per ogni sezione.

#### ADVANTAGES

- Use soft sleeve **type P cold** (it is not heat shrinkable).
- It is a complementary item, so it is not necessary to have stocked **double series of insulated and non insulated terminals** (with related tools for insulated and non insulated terminals).
- As soon as screwed the connection to the switch, there is the possibility to obtain a **total insulation** simply sliding the mobile sleeve until the catch. (Big advantage thinking about risks of possible short circuit in the uncovered part of other kind of insulations).
- Usually supplied in black colour, the **soft sleeve type P** is also available in other **9 different colours** for each sections.

EGI SRL - Via Gobetti, 44 - 20072 Fizzonasco di Pieve Emanuele (MI)

Tel. 02/90.72.19.44 - Fax 02/90.72.46.46 - e-mail: info@egisrl.it - www.egisrl.it

# CAPICORDA DI POTENZA 1,5÷1.000 mm<sup>2</sup>

## POWER TERMINALS 1,5÷1.000 mm<sup>2</sup>

EAC CE



**MATERIALE**  
Tubo rame stagnato

**MATERIAL**  
Tinned copper tube



**CAPPUCCI ISOLANTI  
PER CAPICORDA DA TUBO  
COLORE NERO - TIPO P**

**SOFT SLEEVES FOR TUBE  
TERMINALS COLOUR BLACK  
- TYPE P**

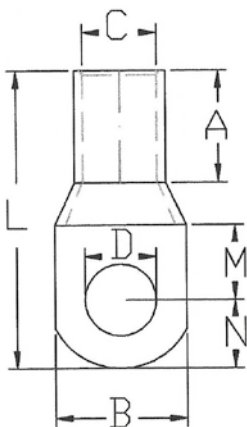

ART.	PEZZI PER CONFEZ. PCS PER PACK.	ARTICOLO ARTICLE	SEZIONE WIRE RANGE mm <sup>2</sup>	D PER VITE SCREW	C	B	L	A	M	N	PEZZI PER CONFEZ. PCS PER BOX
PA	100	AT3	1,5	3	1,8	8	19	5	5	4	100
		AT4	1,5	4	1,8	8	19	5	5	4	100
		AT5	1,5	5	1,8	8	20	5	5	5	100
		AT6	1,5	6	1,8	8	21	5	6	5	100
PB	100	BT3	2,5	3	2,5	9,5	19	6	8	3	100
		BT4	2,5	4	2,5	9,5	19	6	8	4	100
		BT5	2,5	5	2,5	9,5	19	6	7	6	100
		BT6	2,5	6	2,5	9,5	25	6	9	7	100
PB	100	BT8	2,5	8	2,5	10,2	26	6	10	5	100
		CT3	4-6	3	3,7	10	24,5	7	7	5	100
		CT4	4-6	4	3,7	10	24,5	7	7	5	100
		CT5	4-6	5	3,7	11	26	7	7	5	100
PC	100	CT6	4-6	6	3,7	11	27	7	7	6	100
		CT8	4-6	8	3,7	13	30	7	9	8	100
		CT10	4-6	10	3,7	15	33	7	9	8	100
		CT12	4-6	12	3,7	18	42,5	12	12	11	100
PD	100	D3	10	3	4,6	10	27	7,5	7	5	100
		D4	10	4	4,6	10	27	7,5	7	6	100
		D5	10	5	4,6	10	27	7,5	7	6	100
		D6	10	6	4,6	11	28,5	7,5	8	6	100
		D8	10	8	4,6	13	32	7,5	9	8	100
		D10	10	10	4,6	15	37	7,5	11	10	100
		D12	10	12	4,6	18	42	7,5	13	12	100
PD	100	D14/S	10	14	5	21,5	43	11	12,5	10,5	100
		E3	16	3	6	12	29	9	7	6	100
		E4	16	4	6	12	29	9	7	6	100
		E5	16	5	6	12	29	9	7	6	100
		E6	16	6	6	12	29,5	9	7	6	100
		E8	16	8	6	13	32	9	9	8	100
PE	100	E10	16	10	6	15	37	9	11	10	100
		E12	16	12	6	18	41	9	13	12	100
		F4	25	4	7	13	31	10,5	7	6	100
		F5	25	5	7	13	31	10,5	7	6	100
PF	100	F6	25	6	7	13	32	10,5	7	6	100
		F8	25	8	7	13	34,5	10,5	9	8	100
		F10	25	10	7	15	40	10,5	11	10	100
		F12	25	12	7	18	44	10,5	13	12	100
PG	100	G5	35	5	9	17	36	14	7	6	100
		G6	35	6	9	17	38	14	7	6	100
		G8	35	8	9	17	40	14	9	8	100
		G10	35	10	9	18	43	14	11	10	100
		G12	35	12	9	19	47	14	13	12	100
		G14	35	14	9	21	52	14	15	14	100
PG	100	G16	35	16	9	23	54	14	16	16	100

# CAPICORDA DI POTENZA 1,5÷1.000 mm<sup>2</sup>

## POWER TERMINALS 1,5÷1.000 mm<sup>2</sup>

EAC CE



- MATERIALE**  
Tubo rame stagnato
- MATERIAL**  
Tinned copper tube



**CAPPUCCI ISOLANTI  
PER CAPICORDA DA TUBO  
COLORE NERO - TIPO P**

**SOFT SLEEVES FOR TUBE  
TERMINALS COLOUR BLACK  
- TYPE P**

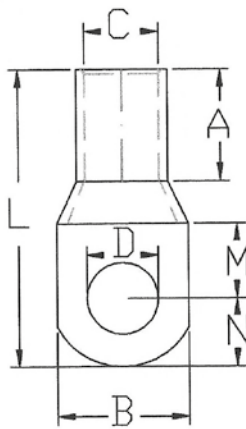

ART.	PEZZI PER CONFEZ. PCS PER PACK.	ARTICOLO ARTICLE	SEZIONE WIRE RANGE mm <sup>2</sup>	D PER VITE SCREW	C	B	L	A	M	N	PEZZI PER CONFEZ. PCS PER BOX
PH	100	H6	50	6	10	20	40	15	9	6,5	50
		H8	50	8	10	20	40	15	9	8	50
		H10	50	10	10	20	44	15	11	10	50
		H12	50	12	10	20	49	15	13	12	50
		H14	50	14	10	21	55	15	15	14	50
		H16	50	16	10	22	59	15	17	16	50
PH	100	H18	50	18	10	22	63	15	20	18	50
		H6F	70-50	6	11	20	42	15,5	9	6,5	50
		H8F	70-50	8	11	20	45	15,5	11	8	50
		H10F	70-50	10	11	20	46	15,5	11	11	50
PI	100	H 12F	70-50	12	11	20	50	15,5	12	13	50
		I6	70	6	12	22	46	18	8	7	50
		I8	70	8	12	22	48	18	10	9,5	50
		I10	70	10	12	22	48,5	18	11	10,5	50
		I12	70	12	12	22	52,5	18	13	12	50
		I14	70	14	12	22	56	18	15	14	50
		I16	70	16	12	23	61	18	16	15	50
PI	100	I18	70	18	12	24	65,5	18	18	18	50
		I21	70	20	12	27	68	18	20	20	50
		I8F	95-70	8	13	23	48	19,5	9	8	50
		I10F	95-70	10	13	23	52	19,5	11	10	50
		I12F	95-70	12	13	23	55	19,5	13	12	50
PI	100	I14F	95-70	14	13	24	60	19,5	15	14	50
		I16F	95-70	16	13	24	63	19,5	17	16	50
		L6	95	6	13,7	26	52,5	20	12,5	9	25
PL	100	L8	95	8	13,7	26	52,5	20	11	9,5	25
		L10	95	10	13,7	26	56	20	13	10,5	25
		L12	95	12	13,7	26	59,5	20	13	12,5	25
		L14	95	14	13,7	26	63	20	15	14	25
		L16	95	16	13,7	26	66	20	17	16	25
		L18	95	18	13,7	26	71	20	20	18	25
		L21	95	20	13,7	26	77	20	21	22	25
		PL	100	L8F	120-95	8	15	27	54	22	9
L10F	120-95			10	15	27	57	22	11	10	25
L12F	120-95			12	15	27	60	22	13	12	25
L14F	120-95			14	15	27	63	22	15	14	25
L16F	120-95			16	15	27	70	22	17	16	25
PM	50	M6	120	6	15,2	29	53	22,5	10	7	25
		M8	120	8	15,2	29	53,5	22,5	11	8	25
		M10	120	10	15,2	29	58,5	22,5	12	11	25
		M12	120	12	15,2	29	62	22,5	13	13	25
		M14	120	14	15,2	29	64,5	22,5	15	14	25
		M16	120	16	15,2	29	68	22,5	17	16	25
		M18	120	18	15,2	29	75	22,5	20	18	25
		M21	120	20	15,2	29	77	22,5	22	20	25
		M22	120	22	15,2	29	84	22,5	25	23,5	25
		PM	50	M8F	150-120	8	16,6	30,5	59	25	10
M10F	150-120			10	16,6	30,5	66	25	12	11	25
M12F	150-120			12	16,6	30,5	68	25	13	13	25
M14F	150-120			14	16,6	30,5	71	25	15	14	25
M16F	150-120			16	16,6	30,5	76	25	17	16	25
M18F	150-120			18	16,6	30,5	77	25	20	18	25
M21F	150-120	20	16,6	30,5	86	25	22	20	25		

# CAPICORDA DI POTENZA 1,5÷1.000 mm<sup>2</sup>

## POWER TERMINALS 1,5÷1.000 mm<sup>2</sup>

EAC CE



**MATERIALE**  
Tubo rame stagnato

**MATERIAL**  
Tinned copper tube



**CAPPUCCI ISOLANTI  
PER CAPICORDA DA TUBO  
COLORE NERO - TIPO P**

**SOFT SLEEVES FOR TUBE  
TERMINALS COLOUR BLACK  
- TYPE P**

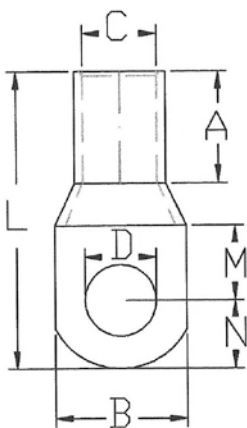

ART.	PEZZI PER CONFEZ. PCS PER PACK.	ARTICOLO ARTICLE	SEZIONE WIRE RANGE mm <sup>2</sup>	D PER VITE SCREW	C	B	L	A	M	N	PEZZI PER CONFEZ. PCS PER BOX
PN	50	N8	150	8	16,7	32	65	25	12	8	20
		N10	150	10	16,7	32	68	25	13	10	20
		N12	150	12	16,7	32	69	25	15	13	20
		N14	150	14	16,7	32	72,5	25	15	14	20
		N16	150	16	16,7	32	74	25	17	16	20
		N18	150	18	16,7	32	78	25	19	18	20
		N21	150	20	16,7	32	84	25	22	20	20
		N22	150	22	16,7	32	86	25	23	21	20
PN	50	N10F	185-150	10	19,2	33,5	69,5	28	14,5	11	20
		N12F	185-150	12	19,2	33,5	73	28	14,5	13	20
		N14F	185-150	14	19,2	33,5	75	28	16	14	20
		N16F	185-150	16	19,2	33,5	77	28	16	15	20
		N21F	185-150	20	19,2	33,5	84	28	20	19	20
PO	50	O8	185	8	19,2	36	71	28	14,5	11	10
		O10	185	10	19,2	36	71	28	14,5	11	10
		O12	185	12	19,2	36	72	28	14,5	12	10
		O14	185	14	19,2	36	75	28	15	14	10
		O16	185	16	19,2	36	80	28	17	16	10
		O18	185	18	19,2	36	83	28	19	18	10
		O21	185	20	19,2	36	86	28	22	19	10
PO	50	O10F	240-185	10	21	37	76	32	14	12	10
		O12F	240-185	12	21	37	78	32	15	13	10
		O14F	240-185	14	21	37	82,5	32	17	15	10
		O16F	240-185	16	21	37	84	32	18	17	10
		O21F	240-185	20	21	37	92	32	22	21	10
PP	25	P8	240	8	21,5	39	76	32	14	11	10
		P10	240	10	21,5	39	76	32	14	11	10
		P12	240	12	21,5	39	79	32	16	13	10
		P14	240	14	21,5	39	82	32	16	14	10
		P16	240	16	21,5	39	85	32	17	16	10
		P18	240	18	21,5	39	90	32	19	18	10
		P21	240	20	21,5	39	95	32	22	20	10
		P22	240	22	21,5	39	95	32	22	20	10
		PQ	25	Q8	300	8	23,7	44	81	36	14
Q10	300			10	23,7	44	82	36	14	12	10
Q12	300			12	23,7	44	83,5	36	15	13	10
Q14	300			14	23,7	44	86,5	36	15	14,5	10
Q16	300			16	23,7	44	90	36	17	16	10
Q18	300			18	23,7	44	98	36	21	18	10
Q21	300			20	23,7	44	102	36	23	20	10
PR	25	R12	400	12	27	50	94	40	17	15	5
		R14	400	14	27	50	95	40	18	15	5
		R16	400	16	27	50	98	40	19	17	5
		R18	400	18	27	50	101	40	20	18	5
		R21	400	20	27	50	110	40	24	21	5
PS	25	S14	500	14	30,3	57	108	49	18	15,5	5
		S16	500	16	30,3	57	111	49	20	17	5
		S18	500	18	30,3	57	121	49	23	18	5
		S21	500	20	30,3	57	123	49	24	20	5
PT	20	T16	630	16	33,4	62	128	60	22	19	5
		T18	630	18	33,4	62	135	60	24	23	5
		T21	630	20	33,4	62	135	60	24	23	5
		U21	800	20	38	71	154	65	34	20	5
		V21	1000	20	44	80	162	70	24	23	5

# CAPICORDA PER RETI DI TERRA E APPLICAZIONI SPECIALI COLLETTO LUNGO - DOPPIA AGGRAFFATURA

4÷1.000 mm<sup>2</sup>

## GROUND NETWORK AND SPECIAL APPLICATIONS

TERMINALS LONG COLLAR-DOUBLE CRIMPING 4÷1.000 mm<sup>2</sup>



**MATERIALE**  
Tubo rame stagnato

**MATERIAL**  
Tinned copper tube

EAC CE

- Capicorda ricavati da tubo di rame e stagnati elettroliticamente.
- Particolarmente robusti vengono normalmente impiegati per la messa a terra di strutture ed apparecchiature sia in ambienti chiusi che all'esterno.
- Trovano largo impiego negli impianti a media tensione, dove sono richieste particolari doti di resistenza alle sollecitazioni elettrodinamiche.

- Copper tube terminals electrolytically tinned.
- As these terminals are very strong, they are usually used for grounding structure and equipment both indoor and outdoor.
- They are widely used in medium voltage installations, where particular resistance skills to electrodynamic stresses are requested.



CAPPUCCI ISOLANTI PER CAPICORDA DA TUBO COLORE NERO - TIPO P

SOFT SLEEVES FOR TUBE TERMINALS COLOUR BLACK - TYPE P

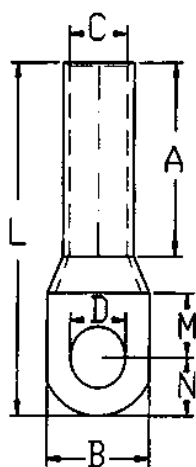

ARTICOLO ARTICLE	SEZIONE WIRE RANGE mm <sup>2</sup>	D PER VITE SCREW	C	B	L	A	M	N	PEZZI PER CONFEZ. PCS PER BOX
CT4L	4-6	4	3,7	11	26	10	7	5	100
CT5L	4-6	5	3,7	11	26	10	7	5	100
CT6L	4-6	6	3,7	11	29	10	8	7	100
CT8L	4-6	8	3,7	13	32	10	9	8	100
CT10L	4-6	10	3,7	15	36	10	11	10	100
D4L	10	4	4,6	11	32,5	12	8	6	100
D5L	10	5	4,6	11	32,5	12	8	6	100
D6L	10	6	4,6	11	33,5	12	8,5	6	100
D8L	10	8	4,6	13	35	12	9	8	100
D10L	10	10	4,6	15	41	12	11	10	100
D12L	10	12	4,6	18	48,5	12	13	12	100
E4L	16	4	6	12	35	15	8	6	100
E5L	16	5	6	12	35	15	8	6	100
E6L	16	6	6	12	36	15	8,5	6	100
E8L	16	8	6	13	38	15	9	8	100
E10L	16	10	6	15	42,5	15	11	10	100
E12L	16	12	6	18	46	15	13	12	100
F4L	25	4	7	13	38	17,5	8	6	100
F5L	25	5	7	13	38	17,5	8	6	100
F6L	25	6	7	13	39	17,5	8,5	6	100
F8L	25	8	7	13	41	17,5	9	8	100
F10L	25	10	7	15	45	17,5	11	10	100
F12L	25	12	7	18	50	17,5	13	12	100
G6L	35	6	9	17	48	23	8	6	100
G8L	35	8	9	17	48	23	9	8	100
G10L	35	10	9	17	53	23	11	10	100
G12L	35	12	9	19	56	23	13	12	100
G14L	35	14	9	21	61	23	15	14	100
G16L	35	16	9	23	63	23	17	16	100
H6L	50	6	10	20	51	25	9	6	50
H8L	50	8	10	20	52	25	10	8	50
H10L	50	10	10	20	54	25	11	10	50
H12L	50	12	10	20	60	25	13	12	50
H14L	50	14	10	21	65	25	15	14	50
H16L	50	16	10	23	69	25	17	16	50



**CAPICORDA PER RETI DI TERRA E APPLICAZIONI SPECIALI COLLETTO LUNGO - DOPPIA AGGRAFFATURA 4÷1.000 mm<sup>2</sup>**  
**GROUND NETWORK AND SPECIAL APPLICATIONS TERMINALS LONG**  
**COLLAR-DOUBLE CRIMPING 4÷1.000 mm<sup>2</sup>**



**CAPPUCCI ISOLANTI PER CAPICORDA DA TUBO COLORE NERO - TIPO P**

**SOFT SLEEVES FOR TUBE TERMINALS COLOUR BLACK - TYPE P**

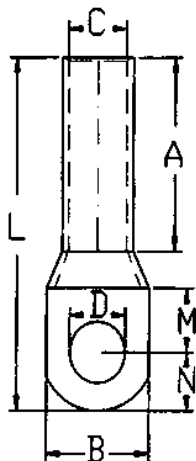

ARTICOLO ARTICLE	SEZIONE WIRE RANGE mm <sup>2</sup>	D PER VITE SCREW	C	B	L	A	M	N	PEZZI PER CONFEZ. PCS PER BOX
I6L	70	6	12	22	60	30	11	6	50
I8L	70	8	12	22	60	30	11	9	50
I10L	70	10	12	22	62	30	12	11	50
I12L	70	12	12	22	65	30	13	12	50
I14L	70	14	12	22	69	30	15	14	50
I16L	70	16	12	23	74	30	17	16	50
I18L	70	18	12	24	77	30	19	18	50
I21L	70	20	12	27	77	30	20	20	50
L8L	95	8	13,7	26	68	34	11	10	25
L10L	95	10	13,7	26	69	34	13	12	25
L12L	95	12	13,7	26	72,5	34	14	12	25
L14L	95	14	13,7	26	76	34	15	14	25
L16L	95	16	13,7	26	79	34	17	16	25
L18L	95	18	13,7	26	85	34	19	18	25
L21L	95	20	13,7	26	90	34	21	20	25
M8L	120	8	15,2	29	74	38	14	11	25
M10L	120	10	15,2	29	74	38	14	11	25
M12L	120	12	15,2	29	76	38	14	13	25
M14L	120	14	15,2	29	81	38	15	14	25
M16L	120	16	15,2	29	81	38	17	16	25
M18L	120	18	15,2	29	91	38	19	18	25
M21L	120	20	15,2	29	95	38	21	20	25
N8L	150	8	16,7	32	84	42	16	13	20
N10L	150	10	16,7	32	84	42	16	13	20
N12L	150	12	16,7	32	84	42	16	14	20
N14L	150	14	16,7	32	86	42	16	15	20
N16L	150	16	16,7	32	90	42	17	16	20
N18L	150	18	16,7	32	95	42	19	18	20
N21L	150	20	16,7	32	99	42	22	20	20
O10L	185	10	19,2	36	97	48	18	14	10
O12L	185	12	19,2	36	97	48	18	14	10
O14L	185	14	19,2	36	99	48	18	16	10
O16L	185	16	19,2	36	101	48	18	18	10
O18L	185	18	19,2	36	102	48	19	18	10
O21L	185	20	19,2	36	108	48	21	20	10
P10L	240	10	21,5	39	99	53	15	11,5	10
P12L	240	12	21,5	39	104	53	17	14	10
P14L	240	14	21,5	39	110	53	20	17	10
P16L	240	16	21,5	39	110	53	20	18	10
P18L	240	18	21,5	39	112	53	20	19	10
P21L	240	20	21,5	39	115	53	22	20	10
Q10L	300	10	23,7	44	108	59	17	15	5
Q12L	300	12	23,7	44	108	59	17	15	5
Q14L	300	14	23,7	44	109	59	17	15	5
Q16L	300	16	23,7	44	115	59	19	17	5
Q18L	300	18	23,7	44	120	59	23	20	5
Q21L	300	20	23,7	44	120	59	23	20	5
R12L	400	12	27	50	130	70	22	18	5
R14L	400	14	27	50	130	70	22	18	5
R16L	400	16	27	50	139	70	27	23	5
R18L	400	18	27	50	139	70	27	23	5
R21L	400	20	27	50	139	70	27	23	5
S14L	500	14	30,3	57	153	75	30	24	5
S16L	500	16	30,3	57	153	75	30	24	5
S18L	500	18	30,3	57	156	75	30	24	5
S21L	500	20	30,3	57	156	75	30	25	5
T16L	630	16	33,4	62	167	85	28	26	5
T18L	630	18	33,4	62	182	85	40	28	5
T21L	630	20	33,4	62	182	85	40	28	5
U16L	800	16	38	71	182	95	40	19	5
U18L	800	18	38	71	182	95	40	19	5
U21L	800	20	38	71	182	95	40	19	5
V21L	1000	20	44	80	203	110	24	23	5

# CAPICORDA DI POTENZA SERIE DIN 6÷240 mm<sup>2</sup>

## POWER TERMINALS DIN COMPLIANT 6÷240 mm<sup>2</sup>



CE

**MATERIALE**  
Tubo rame stagnato

**MATERIAL**  
Tinned copper tube

### NUOVA SERIE DI CAPICORDA CONFORME ALLA NORMATIVA DIN / NEW LUG SERIES DIN COMPLIANT

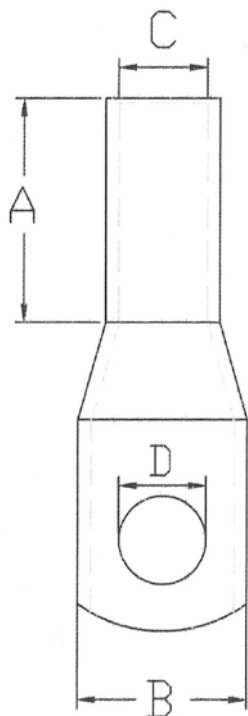

ARTICOLO ARTICLE	SEZIONE WIRE RANGE mm <sup>2</sup>	D PER VITE SCREW	C	B	A	PEZZI PER CONFEZ. PCS PER BOX
CT5D	4-6	5	3,7	11	10	100
CT6D	4-6	6	3,7	11	10	100
CT8D	4-6	8	3,7	13	10	100
D5D	10	5	4,5	11	10	100
D6D	10	6	4,5	11	10	100
D8D	10	8	4,5	13	10	100
D10D	10	10	4,5	15	10	100
E5D	16	5	5,5	12	20	100
E6D	16	6	5,5	12	20	100
E8D	16	8	5,5	13	20	100
E10D	16	10	5,5	15	20	100
E12D	16	12	5,5	18	20	100
F6D	25	6	7	14	20	100
F8D	25	8	7	15	20	100
F10D	25	10	7	15	20	100
F12D	25	12	7	18	20	100
G6D	35	6	8,2	17	20	100
G8D	35	8	8,2	17	20	100
G10D	35	10	8,2	19	20	100
G12D	35	12	8,2	20	20	100
G16D	35	16	8,2	28	20	100
H6D	50	6	10	20	28	50
H8D	50	8	10	20	28	50
H10D	50	10	10	22	28	50
H12D	50	12	10	24	28	50
H16D	50	16	10	28	28	50
I8D	70	8	11,5	24	28	50
I10D	70	10	11,5	24	28	50
I12D	70	12	11,5	24	28	50
I16D	70	16	11,5	30	28	50
I21D	70	20	11,5	30	28	50
L8D	95	8	13,5	28	35	25
L10D	95	10	13,5	28	35	25
L12D	95	12	13,5	28	35	25
L16D	95	16	13,5	32	35	25
L21D	95	20	13,5	33	35	25
M8D	120	8	15,5	31	35	25
M10D	120	10	15,5	31	35	25
M12D	120	12	15,5	31	35	25
M16D	120	16	15,5	32	35	25
M21D	120	20	15,5	36	35	25
N10D	150	10	17	34	35	20
N12D	150	12	17	34	35	20
N16D	150	16	17	34	35	20
N21D	150	20	17	38	35	20
O10D	185	10	19,2	37	40	10
O12D	185	12	19,2	37	40	10
O16D	185	16	19,2	38	40	10
O21D	185	20	19,2	40	40	10
P10D	240	10	21,5	39	40	10
P12D	240	12	21,5	40	40	10
P16D	240	16	21,5	40	40	10
P21D	240	20	21,5	43	40	10

# CAPICORDA AD ATTACCO CONTENUTO (RIDOTTO)

PER INTERRUTTORE DI B.T. 10÷300 mm<sup>2</sup>

POWER REDUCED CONNECTION TERMINALS SUITABLE

FOR L.V. SWITCHES 10÷300 mm<sup>2</sup>



## MATERIALE

Tubo rame stagnato

QUESTA GAMMA DI CAPICORDA È STATA APPPOSITAMENTE STUDIATA PER RISOLVERE IL PROBLEMA DEI COLLEGAMENTI AGLI INTERRUTTORI IN SPAZI RIDOTTI.

LA LARGHEZZA RIDOTTA DELLA PATELLA DEL CAPICORDA PERMETTE INFATTI UN COLLEGAMENTO AGEVOLATO.

## MATERIAL

Tinned copper tube

THIS TERMINAL RANGE HAS BEEN DEVELOPED TO SOLVE CONNECTION MATTERS IN REDUCED SPACES.  
REDUCED PALM WIDTH ALLOW AN EASIER CONNECTION.

EAC CE



MISURE PARTICOLARI A RICHIESTA

DIFFERENT SIZES ON REQUEST

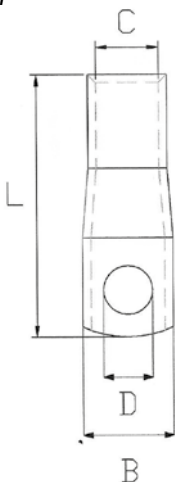

CAPPUCCI ISOLANTI PER CAPICORDA DA TUBO COLORE NERO - TIPO P /

SOFT SLEEVES FOR TUBE TERMINALS COLOUR BLACK - TYPE P

ART.	SEZIONE WIRE RANGE mm <sup>2</sup>	PEZZI PER CONFEZ. PCS PER PACK.	ARTICOLO ARTICLE	SEZIONE WIRE RANGE mm <sup>2</sup>	D PER VITE SCREW	C Ø	B	L	PEZZI PER CONFEZ. PCS PER BOX
PD	10	100	D5R	10	5	4,6	9	27	100
PE	16	100	D8R	10	8	4,6	11	31	100
PF	25	100	E5R	16	5	6	9	32	100
PG	35	100	F5R	25	5	7	9	32,5	100
PH	50	100	F6R	25	6	7	11,5	32,5	100
PI	70	100	G6R	35	6	9	11,5	39	100
PL	95	100	H6R	50	6	10	11,5	42	100
PM	120	50	H8R	50	8	10	15	43	100
PN	150	50	H10R	50	10	10	19	47	100
PO	185	50	I6R	70	6	12	11,5	45	100
PP	240	25	I6R/19	70	6	12	19	46	100
PQ	300	25	I8R	70	8	12	19	50	100
			I10R	70	10	12	19	51	100
			L8R/15,5	95	8	13,7	15,5	56	50
			L8R	95	8	13,7	19	56	50
			L10R	95	10	13,7	19	58	50
			M8R	120	8	15,2	19	61	25
			M10R	120	10	15,2	19	65	25
			M12R	120	12	15,2	19	65	25
			N8R	150	8	16,7	19	70	20
			N10R	150	10	16,7	19	71	20
			N12R/27	150	12	16,7	27	72	20
			O8R	185	8	19,2	31	72,5	10
			O10R/24,5	185	10	19,2	24,5	72	10
			O10R	185	10	19,2	31	72	10
			O12R/24,5	185	12	19,2	24,5	73	10
			O12R	185	12	19,2	31	73	10
			P12R	240	12	21,5	31	80	10
			P16R	240	16	21,5	31	86	10
			Q12R	300	12	23,7	31	83	5

# CAPICORDA DI POTENZA PIEGATI A 90°, 45° O 30° / POWER TERMINALS BENT 90°, 45° OR 30°

## MATERIALE

Tubo rame stagnato

## TIPO

C (curvo)

TUTTI I CAPICORDA DI POTENZA, A RICHIESTA POSSONO ESSERE PIEGATI A 90°, 45° O 30°

## MATERIAL

Tinned copper tube

## TYPE

C (bent)

ON REQUEST, ALL POWER TERMINALS CAN BE BENT TO 90°, 45° OR 30°



# FORCELLE DI POTENZA 10÷70 mm<sup>2</sup> POWER SPADE TERMINALS 10÷70 mm<sup>2</sup>



**MATERIALE**  
Tubo rame stagnato

**MATERIAL**  
Tinned copper tube

**EAC CE**

- Forcelle di potenza con zigrinatura antiscivolo.
- La zigrinatura antiscivolo consente una migliore tenuta sulla vite, rendendo il prodotto più sicuro e facile da utilizzare.
- Particolarmente adatte per i nuovi interruttori con attacco a vite impedibile.

- Spade terminals with anti slip grooves
- Anti slip grooves allow better connection on screw, in order to obtain a product easier to use and safer.
- Suitable for switches with screw with anti-leakage devices.



IL RIVESTIMENTO ISOLANTE SI PUÒ OTTENERE CON IL CAPPUCIO TIPO P NEL COLORE STANDARD NERO, OPPURE NEI 9 COLORI DISPONIBILI

INSULATION CAN BE OBTAINED USING SOFT SLEEVES TYPE P, IN STANDARD COLOR BLACK

A RICHIESTA DISPONIBILI CON FORI VITE DIVERSI

ON REQUEST AVAILABLE DIFFERENT SCREW HOLES

ART.	SEZIONE WIRE RANGE mm <sup>2</sup>	PEZZI PER CONFEZ. PCS PER PACK.	ARTICOLO ARTICLE	SEZIONE WIRE RANGE mm <sup>2</sup>	D PER VITE SCREW	C Ø	B	L	PEZZI PER CONFEZ. PCS PER BOX
PD	10	100	D104	10	4	4,6	11	27	100
PE	16	100	D105	10	5	4,6	11	27	100
PF	25	100	D106	10	6	4,6	11	30	100
PG	35	100	D108	10	8	4,6	13	32	100
PH	50	100	E105	16	5	6	12	29	100
PI	70	100	E106	16	6	6	12	30	100
			E108	16	8	6	13	32	100
			E110	16	10	6	15	35,5	100
			F105	25	5	7	13	31	100
			F106	25	6	7	13	32	100
			F108	25	8	7	13	33,5	100
			G106	35	6	9	17	38	100
			G108	35	8	9	17	40	100
			H106	50	6	10	20	41	50
			H108	50	8	10	20	42	50
			I106	70	6	12	22	46	50
			I108	70	8	12	22	48	50
			I110	70	10	12	22	50	50

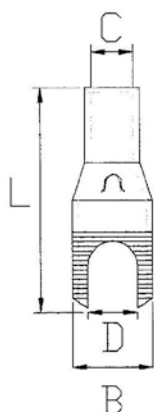

## CAPICORDA PER RETI DI TERRA RISPONDENTI ALLE PRESCRIZIONI ENEL / GROUND TERMINALS COMPLIANT TO ENEL REGULATIONS

**MATERIALE**  
Tubo rame stagnato

**MATERIAL**  
Tinned copper tube

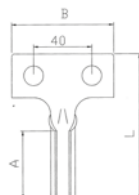
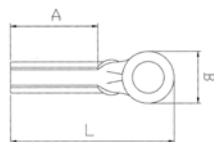

CON PINZA ART. 58  
UTILIZZARE LA COPPIA  
DI MATRICI TIPO M4/5835

WITH TOOL ART. 58  
USE COUPLE  
OF DIES TYPE M4/5835



ARTICOLO ARTICLE	SEZIONE WIRE RANGE mm <sup>2</sup>	D PER VITE SCREW	A	B	L	PEZZI PER CONFEZ. PCS PER BOX
ENE1	35	16	47	28	84	50
ENE2	35	12	48	70	101	25

## CAPICORDA DI POTENZA AD ASOLA PER TRASFORMATORI / BUTTONHOLE POWER TERMINALS

ARTICOLO ARTICLE	SEZIONE WIRE RANGE mm <sup>2</sup>	D PER VITE SCREW	A	B	C	L	PEZZI PER CONFEZ. PCS PER BOX
H12AS/L	50	12	17	21	10	73	50





**EGI**®  
S.r.l.



## CAPPUCCI ISOLANTI TIPO P PER CAPICORDA DI POTENZA

## INSULATING SOFT SLEEVES TYPE P FOR POWER TERMINALS



Il cappuccio isolante per capicorda di potenza è fornito abitualmente nel colore standard nero, ma è disponibile anche in altre **diverse colorazioni per ogni sezione da 1,5 a 630 mm<sup>2</sup>**.

*The insulating soft sleeve for power terminals is usually supplied in standard colour black, but it's also available in **other several colours for every wire range from 1,5 up to 630 mm<sup>2</sup>**.*



### CARATTERISTICHE

- **MATERIALE:** PVC morbido
- **TEMPERATURA MASSIMA:** 90°C
- **PUNTO DI FUSIONE:** 160°C
- **TEMPERATURA MINIMA:** -30°C
- **PROVA DI INVECCHIAMENTO:** 100°Cx120h / -30°Cx30 min.
- **RESISTENZA ELETTRICA SPECIFICA:** 500V 2,13x10<sup>15</sup> cm<sup>2</sup>
- **STABILITÀ CON RAME:** eccellente

### TECHNICAL FEATURES

- **MATERIAL:** soft PVC
- **TEMPERATURE RATING:** 90°C
- **MELTING POINT:** 160°C
- **COLD BEND:** -30°C
- **AGING TEST:** 100°Cx120h / -30°Cx30 min.
- **RESISTIVITY:** 500V 2,13x10<sup>15</sup> cm<sup>2</sup>
- **COPPER STABILITY:** excellent

# CAPICORDA DI POTENZA DOPPIO FORO COLLETTO LUNGO - DOPPIA AGGRAFFATURA / DOUBLE HOLE POWER TERMINALS - LONG BARRELL DOUBLE CRIMPING

## MATERIALE

Tubo rame stagnato



A RICHIESTA POSSIBILITÀ DI REALIZZARE CAPICORDA A DOPPIO FORO CON INTERASSI E FORI VITE DIVERSI DALLA SERIE STANDARD.

## MATERIAL

Tinned copper tube

ON REQUEST POSSIBILITY TO PRODUCE DOUBLE HOLES TERMINALS WITH AXE AND SCREW HOLES DIFFERENT FROM STANDARD SERIES.

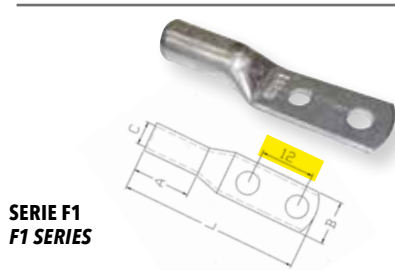

SERIE F1  
F1 SERIES

SERIE F2  
F2 SERIES



R = cavo rotondo  
round cable  
RC = cavo rotondo compatto  
compact round cable  
S = cavo settoriale  
sectorial cable

SERIE F3  
F3 SERIES

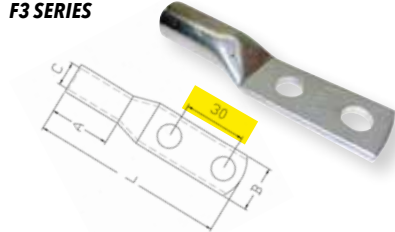

SERIE F4  
F4 SERIES

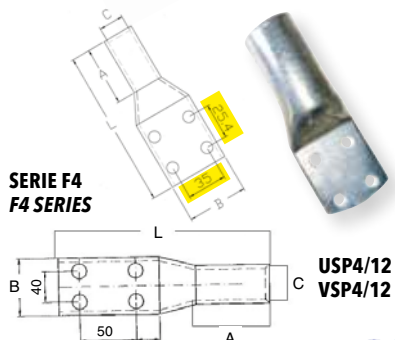

ARTICOLO ARTICLE	SEZIONE WIRE RANGE mm <sup>2</sup>	D PER VITE SCREW	A	B	C	L	PEZZI PER CONFEZ. PCS PER BOX
<b>SERIE F1 - F1 SERIES</b>							
DF1	10	4	12	11	4,6	43	100
EF1	16	4	15	12	6	47	100
FF1	25	4	17,5	13	7	48	100
GF1	35	4	23	17	9	56	100
HF1	50	4	25	20	10	57	50
IF1	70	4	30	22	12	63	50
<b>SERIE F2 - F2 SERIES</b>							
FF2	25	8	17,5	15	7	89	100
FF12	25	12	17,5	18	7	98	100
GF12	35-50	12	23	19	8,2	102	50
HF12	50	12	25	20	10	105	50
IF12	80S-95RC	12	30	22	11,5	113	25
LF2	95-100S	14	34	26	13,7	126	20
MF2/12	120-150RC	12	38	29	15,2	130	20
MF2	120-150RC	14	38	29	15,2	133	20
NF2	150-160RC	14	42	32	16,7	137	20
OF2	185S-240RC	14	48	36	19,2	146	10
PF2	240S-315RC	14	53	39	21,5	154	10
QF2	315S	14	59	44	23,7	156	10
RF2	400R	14	70	50	27	175	5
RF2/12	400R	12	70	50	27	170	5
RF4	400R	16	70	50	27	179	5
SF2	500R	14	75	57	30,6	185	4
SF4	500R	16	75	57	30,6	188	4
TF2/12	600/630R	12	85	62	33,4	197	4
TF2	600/630R	14	85	62	33,4	199	4
TF4	600/630R	16	85	62	33,4	202	4
<b>SERIE F3 - F3 SERIES</b>							
IF3	70	12	30	22	12	102	25
LF3	95	12	34	26	13,7	106	25
MF3	120	12	38	29	15,2	112	25
NF3	150	12	42	32	16,7	118	20
OF3	185	12	48	36	19,2	125	10
PF3	240	12	53	39	21,5	130	10
QF3	300	12	59	44	23,7	138	10
<b>SERIE F4 - F4 SERIES</b>							
RSP5	400	8	40	50	27	121	5
SSP5	500	8	49	57	30,6	134	5
TSP5	630	8	60	62	33,4	150	5
USP4/12	800	12	90	71	38	215	5
VSP4/12	1000	12	110	80	44	235	5

POSSIBILITÀ DI PIEGARE I CAPICORDA A 90° - 45° - 30°  
POSSIBILITY TO BENT LUGS AT 90° - 45° - 30°

# CAPICORDA DI POTENZA INNOVATIVI

## INNOVATIVE POWER TERMINALS

CE

● **MATERIALE**  
Tubo rame stagnato

● **MATERIAL**  
Tinned copper tube

### CAPICORDA DI POTENZA 5 FORI / 5 HOLES POWER TERMINALS



- Nuovo capicorda di potenza 5 fori.
- Sezione: 1.000 mm<sup>2</sup>.

SU RICHIESTA REALIZZABILE ANCHE PER ALTRE SEZIONI / INTERASSI / FORI VITE

- *New power terminal 5 holes.*
- *Wire range: 1.000 mm<sup>2</sup>.*

*ON REQUEST POSSIBILITY TO PRODUCE IN OTHER SECTION, AXE DISTANCE AND SCREW HOLES*

### CAPICORDA DI POTENZA CON FORO ESAGONALE / HEXAGONAL HOLE POWER TERMINAL



- Nuovo capicorda di potenza con foro esagonale per cavi di messa a terra e cortocircuito.
- Il foro esagonale permette di collegare e scollegare il cavo senza togliere il bullone di bloccaggio.
- Senza foro ispezione.
- Sezioni: realizzabile per sezioni da 35 a 150 mm<sup>2</sup>.

- *New power terminal with hexagonal hole for earth wire and short circuit.*
- *The hexagonal hole allows to connect and disconnect cable without remove the locking bolt.*
- *Without inspection hole.*
- *Wire range: achievable for wire range from 35 up to 150 mm<sup>2</sup>.*

### CAPICORDA CON DOPPIO FORO ASOLATO / DOUBLE BUTTОНHOLE TERMINAL



- Nuovo capicorda di potenza B.T. doppio foro di cui un foro M8 e un foro asolato.
- Sezione: realizzabile da 16 a 50 mm<sup>2</sup>.
- Interasse: 12 mm.

- *New power terminal L.V. double hole of which one hole M8 and one buttonhole.*
- *Wire range: achievable from 16 to 50 mm<sup>2</sup>.*
- *Axe distance: 12 mm.*

### CAPICORDA M.T. CON ATTACCO A CODOLO / M.V. PIN TERMINAL



- Nuovo capicorda per media tensione con attacco a codolo per cavi in rame fino a 500 mm<sup>2</sup>.
- In rame elettrolitico, garantisce un'adeguata resistenza meccanica.

- *New power pin terminal for M.V. for copper wire up to 500 mm<sup>2</sup>.*
- *Made in electrolytical tinned copper this terminal guarantees a good mechanical resistance.*

## PINZE MANUALI / MANUAL TOOLS

### PINZE MANUALI PER AGGRAFFARE CAPICORDA DI POTENZA MANUAL TOOLS TO CRIMP POWER TERMINALS



#### ART. 52

- Pinza a cricchetto per capicorda nudi da 1,5 a 10 mm<sup>2</sup>
- Ratchet tool for not insulated terminals, wire range from 1,5 to 10 mm<sup>2</sup>

#### ART. 52BIS

- Pinza a cricchetto per capicorda nudi da 10 a 16 mm<sup>2</sup>
- Ratchet tool for not insulated terminals, wire range from 10 to 16 mm<sup>2</sup>



#### ART. CT38

- Pinza per capicorda nudi da 10 a 50 mm<sup>2</sup>
- Tool for not insulated terminals, wire range from 10 to 50 mm<sup>2</sup>

#### ART. 56

- Pinza con manici allungabili per capicorda nudi da 10 a 185 mm<sup>2</sup>
- Crimping tool with extensible handles for not insulated terminals, wire range from 10 to 185 mm<sup>2</sup>



#### ART. 57BIS

- Pinza per capicorda nudi da 10 a 120 mm<sup>2</sup>
- Crimping tool for not insulated terminals, wire range from 10 to 120 mm<sup>2</sup>

#### ART. CT100

- Pinza per capicorda nudi da 25 a 120 mm<sup>2</sup>
- Crimping tool for not insulated terminals, wire range from 25 to 120 mm<sup>2</sup>



#### ART. CT150

- Pinza per capicorda nudi da 10 a 150 mm<sup>2</sup>
- Crimping tool for not insulated terminals, wire range from 10 to 150 mm<sup>2</sup>

#### ART. 57

- Pinza per capicorda nudi da 10 a 120 mm<sup>2</sup>
- Crimping tool for not insulated terminals, wire range from 10 to 120 mm<sup>2</sup>



#### ART. HX50

- Pinza per crimpatura esagonale per capicorda nudi da 10 a 50 mm<sup>2</sup>
- Hexagonal crimping tool for not insulated terminals, wire range from 10 to 50 mm<sup>2</sup>

#### ART. HX120B

- Pinza per crimpatura esagonale per capicorda nudi da 10 a 120 mm<sup>2</sup>
- Hexagonal crimping tool for not insulated terminals, wire range from 10 to 120 mm<sup>2</sup>





# CAPICORDA DI MEDIA TENSIONE - SERIE PESANTE

## HEAVY SERIES POWER TERMINALS



**MATERIALE**  
Tubo rame stagnato

**MATERIAL**  
Tinned copper tube

### CAPICORDA AD OCCHIELLO / RING TERMINALS

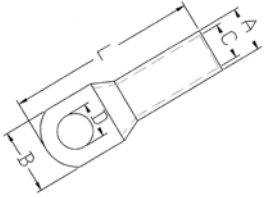

ARTICOLO ARTICLE	SEZIONE WIRE RANGE mm <sup>2</sup>	D PER VITE SCREW	A	B	C	L	PEZZI PER CONFEZ. PCS PER PACK.
F12MT	25R-35RC	12	10	18	7	62	100
G12MT	50S	12	12,5	20	8,2	74	50
H12MT	50S	12	14,5	20	10	72	50
I12MT	70S-80S	12	16,5	29	11,5	76	50
L12MT	80S-95RC	12	19	29	13,5	79	25
M12MT	95S-100S	12	21	29	15,5	79	20
N12MT	120RC/S-150RC	12	23	32	15	85	10
O14MT/L	185-240	14	26,5	42,5	19,3	107	10

R = cavo rotondo  
R = round cable

RC = cavo rotondo compatto  
RC = compact round cable

S = cavo settoriale  
S = sectorial cable

### GIUNTI DI MEDIA TENSIONE - SERIE PESANTE / BUTT SPLICES - HEAVY SERIES

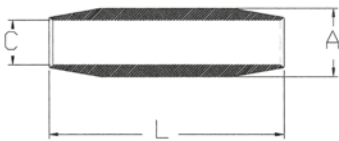

ARTICOLO ARTICLE	SEZIONE WIRE RANGE mm <sup>2</sup>	A	C	L	PEZZI PER CONFEZ. PCS PER PACK.
F20MT	25R	11	7	60	100
G20MT	30RC/S-40S	12,5	8,2	60	100
H20MT	50	14,5	10	60	50
I20MT	63-70	16,5	11,5	70	50
L20MT	80S-95RC	20	12	80	25
M20MT	95S-100S	20	13,5	80	25
N20MT	120RC/S-150RC	23	15	80	20
O20MT	160RC-185	26,5	19,3	100	10
P20MT	200S-240RC	24,4	19,2	100	10
Q20MT	240S-315RC	27,5	21,5	100	10
R20MT	315S	30,6	23,7	100	5
S20MT	400R	35	27	120	5
T20MT	500R	39,5	30,3	120	3
U20MT	600R-630R	43	33,4	130	3

R = cavo rotondo  
R = round cable

RC = cavo rotondo compatto  
RC = compact round cable

S = cavo settoriale  
S = sectorial cable

### GIUNTI A PIENA TRAZIONE IN RAME PER LINEE AEREE / FULL TENSION COPPER SPLICES

**MATERIALE**  
Rame elettrolitico

**MATERIAL**  
Electrolytic copper



ARTICOLO ARTICLE	SEZIONE WIRE RANGE mm <sup>2</sup>	Ø CAVO CABLE	L	PEZZI PER CONFEZ. PCS PER PACK.
EGTR10	10	5	51	25
EGTR16	16	6	61	10
EGTR25	25	7	81	10
EGTR35	35	8,2	92	10
EGTR35E	35	8,2	250	10
EGTR50	50	10	115	10
EGTR70	70	11,5	115	10
EGTR95	95	13,5	196	10
EGTR120	120	15,5	196	5
EGTR150	150	17	200	5

- I giunti a piena trazione trovano impiego nelle linee aeree con conduttori in rame.
- Oltre a garantire una perfetta conducibilità elettrica, sono dimensionati per resistere agli sforzi meccanici dei conduttori nelle linee aeree.
- Giunto ricavato da tubo di rame. Progettato e costruito per assicurare una maggiore resistenza alle sollecitazioni meccaniche di trazione.

**NORME E UNIFICAZIONI:**  
CEI 7-9 / CEI 11-4 (certificazione I.S.P.T.)

- Heavy strength sleeves are used in aerial lines with copper conductors.
- As well as ensuring an excellent electrical conductivity, the dimensions can guarantee mechanical strength resistance for aerial lines conductors.
- Made of copper tube, they are designed and manufactured to guarantee a better resistance to mechanical traction stresses.

**STANDARDS:**  
CEI 7-9 / CEI 11-4 (I.S.P.T. certification)

# CAPICORDA IN ALLUMINIO / ALUMINIUM TERMINALS

**MATERIALE**  
Alluminio con purezza non inferiore a 99,5%

**MATERIAL**  
Aluminium 99,5%

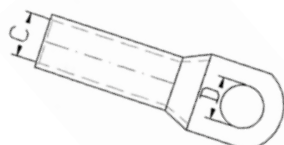

CE

ARTICOLO ARTICLE	SEZIONE WIRE RANGE mm <sup>2</sup>	D PER VITE SCREW	C	PEZZI PER CONFEZ. PCS PER PACK.
D6A	10	6	4,6	100
E6A	16	6	6	50
E8A	16	8	6	50
F6A	25	6	7	50
F8A	25	8	7	50
G8A	35	8	8	50
G10A	35	10	8	50
H10A	50	10	10	25
H12A	50	12	10	25
I10A	70	10	11,5	25
I12A	70	12	11,5	25
L12A	95	12	13,5	25
M12A	120	12	15	20
N12A	150	12	16,5	20
O12A	185	12	18,5	10
P12A	240	12	21	10
Q12A	300	12	22,5	5

## GIUNTI DRITTI M.T. PER CAVI IN ALLUMINIO / ALUMINIUM JOINTING SLEEVES FOR ALUMINIUM CABLES

**MATERIALE**  
Alluminio con purezza non inferiore a 99,5%

**MATERIAL**  
Aluminium 99,5%

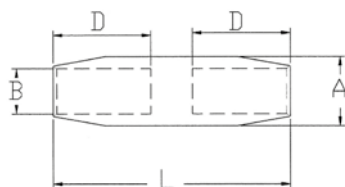

ARTICOLO ARTICLE	SEZIONE WIRE RANGE mm <sup>2</sup>	Ø A	Ø B	D	L	PEZZI PER CONFEZ. PCS PER PACK.
E20A	16	16	5,5	42,5	90,5	25
F20A	25	16	6,5	42,5	90,5	25
G20A	35	16	8	42,5	90,5	25
H20A	50	20	9	50	106,5	25
I20A	70	20	11	66	138	25
L20A	95	20	12,5	67,5	138	25
M20A	120	25	13,7	80,5	164	10
N20A	150	25	15,5	80	164	10
O20A	185	32	17	84	176	10
P20A	240	32	19,5	86	176	10
Q20A	300	36	23,5	108	228	5
R20A	400	36	26	108	228	5

I connettori vengono forniti opportunamente trattati internamente / Aluminium interior covered with special grease for best electrical contact

A richiesta giunti speciali per sezioni diverse o superiori / Special jointing sleeves can be supplied on request

## GIUNTI M.T. A SEZIONI DIVERSE: CAVO PRINCIPALE IN ALLUMINIO E RIDUZIONE IN ALLUMINIO O RAME / ALUMINIUM JOINTING SLEEVES WITH DIFFERENT WIRE RANGE

**MATERIALE**  
Alluminio con purezza non inferiore a 99,5%

**MATERIAL**  
Aluminium 99,5%

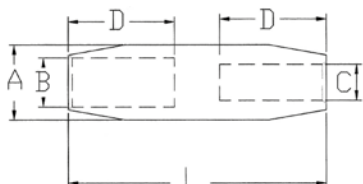

ARTICOLO ARTICLE	SEZIONE WIRE RANGE mm <sup>2</sup>	Ø A	Ø B	Ø C	D	L	PEZZI PER CONFEZ. PCS PER PACK.
I20AR	70-50	20	11	9,5	67	138	10
L20AR	95-50	20	12,8	9,5	67	138	10
L20AR-1	95-70	20	12,8	11	67	138	10
M20AR	120-70	25	14	11	80	164	10
M20AR-1	120-95	25	14	12,8	80	164	10
N20AR	150-95	25	15,8	12,8	80	164	10
N20AR-1	150-120	25	15,8	14	80	164	10
O20AR	185-120	32	17,5	14	85	176	10
O20AR-1	185-150	32	17,5	15,8	85	176	10
P20AR	240-150	32	19,8	16,8	85	176	10
P20AR-1	240-185	32	19,8	17,5	85	176	10
Q20AR	300-240	36	23,5	19,8	108	228	5
Q20AR-1	400-300	36	26	23,5	108	228	5

I connettori vengono forniti opportunamente trattati internamente / Aluminium interior covered with special grease for best electrical contact

A richiesta giunti speciali per sezioni diverse o superiori / Special jointing sleeves can be supplied on request

# CAPICORDA E CONNETTORI MECCANICI CON VITE A ROTTURA / SCREW TERMINALS AND CONNECTORS



CE

## MATERIALE

Capicorda e connettori in alluminio 99,5% con superficie stagnata

## BULLONI

Ottone stagnato

## MATERIAL

Terminals and connectors in aluminium 99,5% tin plated surface

## BOLTS

Tinned brass

# CAPICORDA E CONNETTORI MECCANICI CON VITE A ROTTURA PER MEDIA E BASSA TENSIONE PER CAVO IN RAME E ALLUMINIO / ALUMINIUM SCREW TERMINALS AND CONNECTORS FOR MEDIUM AND LOW TENSION AND SUITABLE FOR COPPER AND ALUMINIUM CABLES

## CARATTERISTICHE

- Design compatto
- Vasta gamma di applicazioni
- Può essere usato con conduttori in rame e alluminio flessibili e solidi fino a 30Kv
- Facile installazione

## CHARACTERISTICS

- Compact design
- Large range of applications
- For stranded and solid copper and aluminium conductor up to 30Kv
- Easy to install

## VANTAGGI DELLA VITE A STRAPPO

- Varietà di misure da 16 a 400 mm<sup>2</sup>
- Facile da assemblare anche in condizioni difficoltose
- Necessita solo di una chiave inglese

## ADVANTAGES OF TEAR-OFF SCREW

- Variety of sizes from 16 up to 400 mm<sup>2</sup>
- Easy to assembly even under difficult conditions
- It only needs a wrench

# CAPICORDA MECCANICI CON VITE A ROTTURA / SCREW TERMINALS



ARTICOLO ARTICLE	SEZIONE WIRE RANGE mm <sup>2</sup>	PER VITE SCREW	NUMERO BULLONI BOLTS Q.TY	PEZZI PER CONFEZ. PCS PER PACK.
EAL16-95/12	16-95	12	1	10
EAL50-150/12	50-150	12	1	10
EAL50-150/16	50-150	16	1	10
EAL95-240/12	95-240	12	2	5
EAL95-240/16	95-240	16	2	5
EAL120-300/12	120-300	12	2	5
EAL120-300/16	120-300	16	2	5
EAL185-400/12	185-400	12	3	5
EAL185-400/16	185-400	16	3	5

# CONNETTORI MECCANICI CON VITE A ROTTURA / SCREW CONNECTORS



ARTICOLO ARTICLE	SEZIONE WIRE RANGE mm <sup>2</sup>	LUNGHEZZA LENGTH	NUMERO BULLONI BOLTS Q.TY	PEZZI PER CONFEZ. PCS PER PACK.
EAL20/16-95	16-95	70	2	5
EAL20/50-150	50-150	85	2	5
EAL20/95-240	95-240	120	4	5
EAL20/120-300	120-300	142	4	5
EAL20/185-400	185-400	170	6	5

A richiesta sezioni superiori / On request higher sections

## CAPICORDA BIMETALLICI ALLUMINIO-RAME CON ATTACCO A OCCHIELLO PER CAVI IN ALLUMINIO / ALUMINIUM-COPPER BIMETALLIC RING TERMINALS FOR ALUMINIUM CABLES



CE

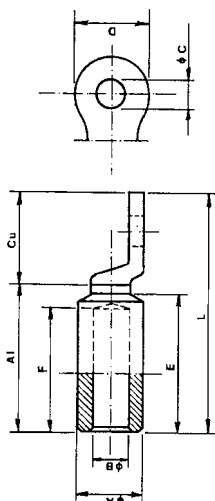

### MATERIALE

Occhiello in rame elettrolitico  
99,9% - CU ETP UNI 5649

Colletto in alluminio con purezza  
non inferiore a 99,5%

### MATERIAL

Electrolytic copper ring ETP 99,9%  
99,5% aluminium lug

ARTICOLO ARTICLE	SEZIONE WIRE RANGE mm <sup>2</sup>	Ø A	Ø B	Ø C	D	E	L	PEZZI PER CONFEZ. PCS PER PACK.
F12B	25	16	6,6	13	22,5	47,5	87	50
G12B	35	20	8,2	13	25	47,5	88	50
H12B	50	20	9,2	13	25	47,5	88	50
I12B	70	20	11,2	13	25	47,5	88	50
L12B	95	20	12,7	13	25	47,5	88	50
M12B	120	25	13,9	13	32	64,5	113	25
N12B	150	25	15,7	13	32	64,5	113	20
O12B	185	32	17,2	13	35,5	64,5	118	10
P12B	240	32	19,7	13	35,5	64,5	118	10
Q16B	300	34	23,3	13/17	35,5	90	145	10
R16B	400	40	26	13/17	35,5	95	150	5

- Capicorda bimetallici per impieghi su cavi in alluminio M.T. e B.T. costituiti da un occhiello in rame e un colletto in alluminio saldati fra di loro mediante frizione sotto compressione.
- I capicorda vengono forniti opportunamente trattati internamente.

- Bimetallic terminals Al-Cu for M.V. and L.V. aluminium cables composed by copper ring and aluminium barrel friction welded.
- Aluminium interior covered by a special grease for best electrical contact.

## CAPICORDA BIMETALLICI ALLUMINIO-RAME CON ATTACCO A CODOLO PER CAVI IN ALLUMINIO / ALUMINIUM-COPPER BIMETALLIC PIN TERMINALS FOR ALUMINIUM CABLES



CE

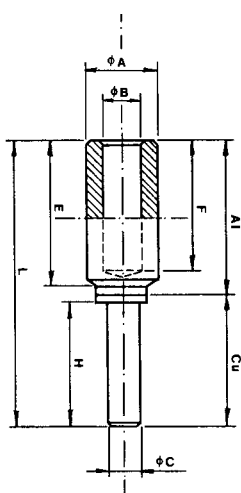

### MATERIALE

Codolo in rame elettrolitico  
99,9% - CU ETP UNI 5649

Colletto in alluminio con purezza  
non inferiore a 99,5%

### MATERIAL

Electrolytic copper pin ETP 99,9%  
99,5% aluminium lug

ARTICOLO ARTICLE	SEZIONE WIRE RANGE mm <sup>2</sup>	Ø A	Ø B	Ø C	E	F	H	L	PEZZI PER CONFEZ. PCS PER PACK.
FCB	25	13	6,5	8	47,5	43	30	82	10
GCB	35	13	8	8	47,5	43	30	82	10
HCB	50	20	9,5	12	47,5	43	45	97	10
ICB	70	20	11	12	47,5	43	45	97	10
LCB	95	20	12,8	12	47,5	43	60	112	10
MCB	120	25	14	14	64,5	60	60	130	10
NCB	150	25	15,8	14	64,5	60	60	130	10
OCB	185	32	17,5	14	64,5	60	60	130	10
PCB	240	32	19,8	14	64,5	60	60	130	10
QCB	300	34	23,5	18	90	85	60	158	5
RCB	400	40	26	18	90	85	60	158	5

- Capicorda bimetallici per impieghi su cavi in alluminio M.T. e B.T. costituiti da un codolo in rame e un colletto in alluminio saldati fra di loro mediante frizione sotto compressione.
- I capicorda vengono forniti opportunamente trattati internamente.

- Bimetallic terminals Al-Cu for M.V. and L.V. aluminium cables composed by copper pin and aluminium barrel friction welded.
- Aluminium interior covered by a special grease for best electrical contact.

## CAPICORDA A MORSETTO / CABLE CLAMPS

CE



- **MATERIALE**  
Ottone nichelato
- **MATERIAL**  
Nickel plated brass

## CAPICORDA A MORSETTO 2 BULLONI / CLAMP TERMINAL 2 BOLTS



ARTICOLO ARTICLE	SEZIONE WIRE RANGE mm <sup>2</sup>	Ø A PER VITE SCREW	B (mm)	C (mm)	D (mm)	L (mm)	PEZZI PER CONFEZ. PCS PER PACK.
355	10-16	8	16	5	12,5	36	100
356	25	10	17,5	5	16	42,5	100
357	35	10	21	7	15,5	47,5	50

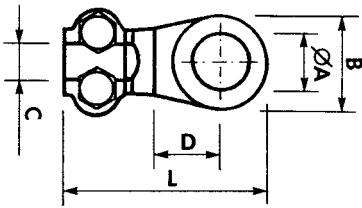

2 bulloni Ø A standard  
2 bolts Ø A standard

## CAPICORDA A MORSETTO 4 BULLONI / CLAMP TERMINAL 4 BOLTS



ARTICOLO ARTICLE	SEZIONE WIRE RANGE mm <sup>2</sup>	Ø A PER VITE SCREW	B (mm)	C (mm)	D (mm)	L (mm)	PEZZI PER CONFEZ. PCS PER PACK.
358	50	10	21,5	8	16	56,5	50
360	75	12	27	12	20	64	50
361	100	16	30	12	21,5	68,5	25
362	125	15	33,5	14	22	74	25
363	150	14	34	16	22	75	25
364	175	14	36	16	21	78	25
365	200	16	36	18	23	86	10
366	250	16	40	18	32	98	10
367	300	18	44,5	20	30	108	10
368	400/500	22	53	25,5	32	132	10

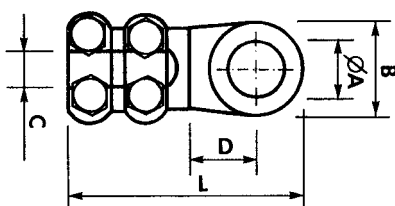

4 bulloni Ø A standard  
4 bolts Ø A standard

EGI si riserva di apportare variazioni e miglioramenti ai prodotti senza obbligo di preavviso.  
EGI can modify or improve products without any notice.

# CONNETTORI A "C" / "C" CONNECTORS

CE

**MATERIALE**

Rame elettrolitico 99,9

**MATERIAL**

99,9 electrolytic copper

A RICHIESTA DISPONIBILI ANCHE STAGNATI  
ON REQUEST AVAILABLE ALSO TINNED

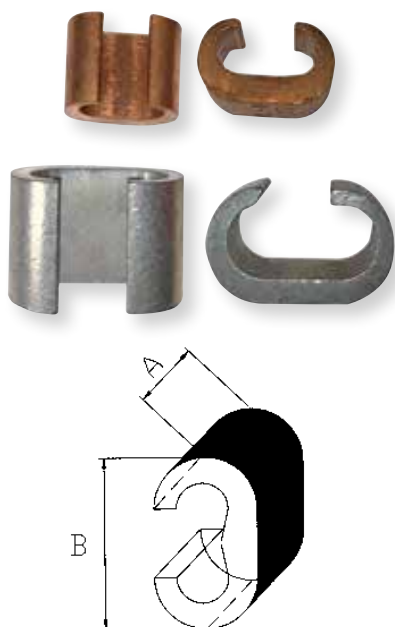

ARTICOLO ARTICLE	SEZIONE WIRE RANGE mm <sup>2</sup>	PASSANTE WIRE RANGE mm <sup>2</sup>	DERIVATO WIRE RANGE mm <sup>2</sup>	A	B	PEZZI PER CONFEZ. PCS PER PACK.
GC1	6-6	6-2,5	6-1,5	9	10	100/500
GC2	10-10	10	10-1,5	12	11,8	100/250
GC3	16-16	16	16-1,5*	17	19,4	100
GC4	25-10	25-16	10-1,5*	17	18,6	100
GC5	25-25	25	25-16	17	20,6	100
GC6	35-16	35	16-6*	20,5	24,9	50
GC7	35-35	35	35-25	20,5	26,6	50
GC8	70-35	70-50	35-6*	24	31,4	25
GC9	70-70	70-50	70-50	24	31,4	25
GC10	95-35	95	35-6*	25	41,2	20
GC11	95-70	95	70-35	25	40,9	20
GC12	95-95	95	95	29	40,9	20
GC13	120-120	120	120-25	30	44,6	10
GC14	150-150	150	150-120	31	45,3	10
GC15	185-95	185-150	95-16	31	44,4	10
GC16	240-120	240-150	120-95	24	68	10
GC17	185-185	185	185	22,6	68	10
GC18	240-240	240	240	25	69	10
GC19	300-300	300	300	30	65	10

\*Si consiglia di raddoppiare il conduttore / \*It is suggested to double conductor

## PINZE DA UTILIZZARE CON I GIUNTI A "C" / TOOLS TO USE WITH "C" CONNECTORS

MATRICI DA UTILIZZARE PER I GIUNTI A "C" - DIES TO USE FOR "C" CONNECTORS

PINZA/TOOL	6 mm <sup>2</sup>	10 mm <sup>2</sup>	16 mm <sup>2</sup>	25 mm <sup>2</sup>	35 mm <sup>2</sup>	50 mm <sup>2</sup>	70 mm <sup>2</sup>	95 mm <sup>2</sup>	120 mm <sup>2</sup>	150 mm <sup>2</sup>	185 mm <sup>2</sup>
ART. 55 e 55BAT	M2/556	M2/5510	M2/551625	M2/5535	M2/555070						
ART. 58	M2/58610		M2/581625	M2/5835	M2/585070	M2/5895			M2/58120185		
ART. 59			M2/591625	M2/5935	M2/595070		M2/5995120				



# TRECCE FLESSIBILI / FLEXIBLE BRAIDS

CE

A RICHIESTA DISPONIBILI ANCHE STAGNATE  
MISURE SPECIALI A RICHIESTA

**MATERIALE**  
Rame ETP

ON REQUEST AVAILABLE ALSO TINNED  
SPECIAL SIZES ON REQUEST

**MATERIAL**  
ETP copper



ARTICOLO ARTICLE	SEZIONE WIRE RANGE mm <sup>2</sup>	LUNGHEZZA LENGTH L	LARGHEZZA WIDTH B	PER VITE SCREW D	PEZZI PER CONFEZ. PCS PER PACK.
T1	10	150	17	8	100
T2	10	200	17	8	100
T3	10	250	17	8	100
T4	16	150	17	8	100
T5	16	200	17	8	100
T6	16	250	17	8	100
T7	16	320	17	8	50
T8	16	350	17	8	50
T9	16	420	17	8	50
T10	16	570	17	8	50
T11	16	660	17	8	50
T12	25	150	23	8	100
T13	25	200	23	8	100
T14	25	250	23	8	100
T15	25	300	23	8	50

• Treccie flessibili impiegate per collegamenti di massa nell'industria elettromeccanica, ferroviaria ed automotive.

• Flexible braids for earth connection used in the electromechanical, railway and automotive industry



## EGI S.r.l.





### CAPICORDA IN ACCIAIO INOX INOX STEEL POWER TERMINALS

Su richiesta la serie dei capicorda di potenza può ora essere prodotta anche in acciaio INOX. Anche in piccoli quantitativi e con tempi ridotti.

**I capicorda in acciaio INOX sono particolarmente adatti per le connessioni ad alte temperature e in ambienti particolarmente difficili, ma l'impiego principale è nel settore nautico e marino.**

**MATERIALE**  
Acciaio INOX

*On request, the power terminal series can now be produced also in Stainless steel. Also for small quantities and in short times.*

**Stainless steel terminals are particularly suitable for connection at high temperatures, and in particularly difficult environments, but the main use is in the nautical and marine sectors.**

**MATERIAL**  
INOX steel

www.egisrl.it

## MORSETTI BIFILARI A PETTINE / CABLE CLAMPS

CE

—● **MATERIALE**  
Ottone

—● **MATERIAL**  
Brass

### MORSETTO BIFILARE A PETTINE 1 BULLONE / CLAMP TERMINAL 1 BOLT

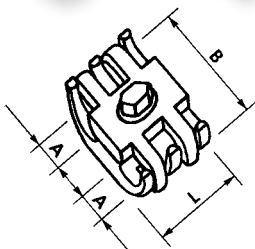

ARTICOLO ARTICLE	SEZIONE WIRE RANGE mm <sup>2</sup>	Ø A PER CAVO CABLE	B (mm)	L (mm)	PEZZI PER CONFEZ. PCS PER PACK.
323	6-16	3-5	24	20,5	50
326	16-50	6-8	29	24	50
329	35-70	9-12	40,5	30	50

### MORSETTO BIFILARE A PETTINE 2 BULLONI / CLAMP TERMINAL 2 BOLTS

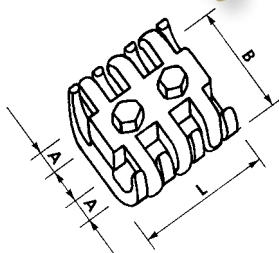

ARTICOLO ARTICLE	SEZIONE WIRE RANGE mm <sup>2</sup>	Ø A PER CAVO CABLE	B (mm)	L (mm)	PEZZI PER CONFEZ. PCS PER PACK.
333	6-16	3-5	24,5	32	50
336	25-50	6-8	30,5	37,5	50
339	35-70	9-12	41,5	44	25
342	70-95	12-14	54	53	10
344	95-150	14-16	52	54,6	10
346	150-300	16-22	66	67	5

## MORSETTI PER MESSA A TERRA / CLAMPS FOR EARTHING DERIVATION

CE

—● **MATERIALE**  
Base in alluminio  
e bullone in acciaio  
nichelato

—● **MATERIAL**  
Aluminium body  
and nickel steel bolt

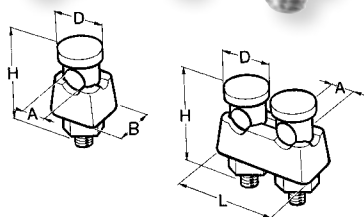

ARTICOLO ARTICLE	SEZIONE WIRE RANGE mm <sup>2</sup>	Ø A CONDUTTORI CONDUCTOR	L	D	H	PEZZI PER CONFEZ. PCS PER PACK.
OD1 (Figura 1)	50	10	26,2	21	33,7	10
OD2 (Figura 2)	50	10	51	21	42	5



# MORSETTI DI DERIVAZIONE / DERIVATION CABLE CLAMPS

CE

—● **MATERIALE**  
Ottone nichelato

—● **MATERIAL**  
Nickel plated brass

## MORSETTO DI DERIVAZIONE PRESSOFUSO / BRASS NICKEL PLATED DERIVATION CLAMPING LUGS

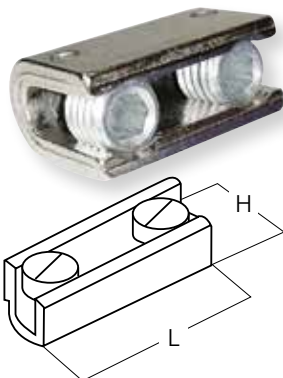

ARTICOLO ARTICLE	SEZIONE WIRE RANGE mm <sup>2</sup>	Ø A PER CAVO CABLE	L (mm)	H (mm)	PEZZI PER CONFEZ. PCS PER PACK.
090	4-16	2-4,5	23	15,2	100
091	16-25	3-6	30	20	100
092	25-35	7-8	42	22,5	50
093	35-70	9-10	51	26	25
094	70-95	11-13	71	30	10
095	95-185	14-16	73	38	10

"U" - 2 GRANI  
"U" TYPE - 2 SCREWS

## MORSETTO DI DERIVAZIONE PRESSOFUSO / BRASS NICKEL PLATED DERIVATION CLAMPING LUGS

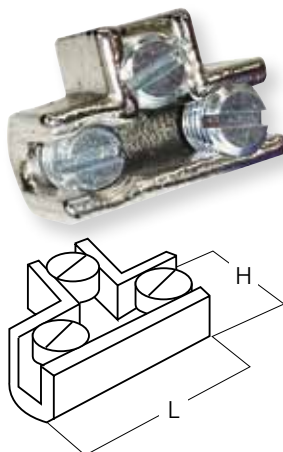

ARTICOLO ARTICLE	SEZIONE WIRE RANGE mm <sup>2</sup>	Ø A PER CAVO CABLE	L (mm)	H (mm)	PEZZI PER CONFEZ. PCS PER PACK.
096	4-16	2-4,5	23	14	100
097	10-25	3-6	30	19	100
098	25-35	7-8	42,5	21	50
099	35-70	9-10	52	25	25

"T" - 3 GRANI  
"T" TYPE - 3 SCREWS

EGI si riserva di apportare variazioni e miglioramenti ai prodotti senza obbligo di preavviso.  
EGI can modify or improve products without any notice.

## MORSETTI VOLANTI ISOLATI / SINGLE END TERMINAL BLOCK

CE



—● **MATERIALE**  
Guscio morsetto in policarbonato trasparente.  
Inserto in ottone e viti di serraggio in acciaio zincato.

—● **MATERIAL**  
Transparent polycarbonate terminal shell.  
Brass insert and zinc plated steel screws.

### CARATTERISTICHE DI IMPIEGO

Morsetti adatti ad applicazioni in scatole di derivazione incassate o esterne.

### USE FEATURES

Terminal blocks for derivations in embadded and external boxes.

ARTICOLO ARTICLE	SEZIONE WIRE RANGE mm <sup>2</sup>	PEZZI PER CONFEZ. PCS PER PACK.
802	2,5	100
803	6	100
804	10	100

# PRESSACAVI IN OTTONE NICHELATO E DADI / NICKEL BRASS CABLE GLANDS AND LOCK NUT

## PRESSACAVI / CABLE GLANDS



CE

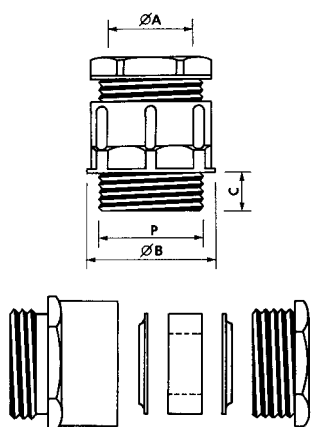

- **MATERIALE** Ottone nichelato  
**GRADO DI PROTEZIONE** IP54  
**DIMENSIONI** a norma DIN 46 320  
**TEMPERATURA D'ESERCIZIO** -20°C +70°C  
**PER BREVI PERIODI** +120°C

- **MATERIAL** Nickel brass  
**PROTECTION DEGREE** IP54  
**SIZES** compliant to DIN 46 320  
**RANGE OF TEMPERATURE** -20°C +70°C  
**FOR SHORT PERIOD** +120°C

### FILETTO PASSO GAS / GAS THREAD

ARTICOLO ARTICLE	PASSO THREAD P	Ø A MIN-MAX (mm)	FORO FISSAGGIO FIXING HOLE (mm)	B CHIAVE SPANNER (mm)	C (mm)	PEZZI PER CONFEZ. PCS PER PACK.
OT0/N	1/4"	4-6	13	14	5	100
OT1/N	3/8"	8-10	17	17	6	100
OT2/N	1/2"	10-12	21,5	22	7	100
OT3/N	5/8"	12-14	23	24	7,5	100
OT4/N	3/4"	17-19	27	30	8,5	50
OT5/N	1"	19-22	33	35	9	50
OT6/N	1-1/8"	26-28	38	40	10,5	25
OT7/N	1-1/4"	26-30	42	45	10,5	25
OT8/N	1-1/2"	33-35	48	50	12	25
OT9/N	2"	43-45	60	64	12	10
OT10/N	2-1/2"	55-57	76	80	12	3
OT11/N	3"	67-69	89	95	20	3

## DADI ESAGONALI / HEXAGONAL LOCK NUT



CE

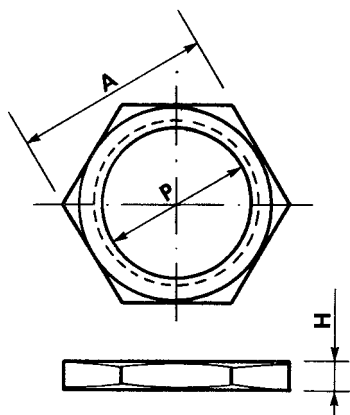

- **DIMENSIONI** a norma DIN  
**TESTINE** DIN 46 320  
**DADI** DIN 46 320 FORM M-NS
- **SIZES** compliant to DIN  
**PRESSING-SCREW** DIN 46 320  
**LOCK NUT** DIN 46320 FORM M-NS

### FILETTO PASSO GAS / GAS THREAD

ARTICOLO ARTICLE	PASSO THREAD P	A (mm)	H (mm)	PEZZI PER CONFEZ. PCS PER PACK.
RT0/N	1/4"	15	2,8	100
RT1/N	3/8"	19	3,2	100
RT2/N	1/2"	24	3,75	100
RT3/N	5/8"	26	3,75	100
RT4/N	3/4"	30	4	50
RT5/N	1"	37	4,5	50
RT6/N	1-1/8"	42	5	25
RT7/N	1-1/4"	46	5	25
RT8/N	1-1/2"	54	5,5	25
RT9/N	2"	65	5,7	10
RT10/N	2-1/2"	80	7	3
RT11/N	3"	95	8	3

# PRESSACAVI IN OTTONE NICHELATO E DADI / NICKEL BRASS CABLE GLANDS AND LOCK NUT

## PRESSACAVI / CABLE GLANDS



CE

- **MATERIALE** Ottone nichelato  
**GRADO DI PROTEZIONE** IP54  
**DIMENSIONI** a norma DIN 46 320  
**TEMPERATURA D'ESERCIZIO** -40°C +100°C
- **MATERIAL** Nickel brass  
**PROTECTION DEGREE** IP54  
**SIZES** compliant to DIN 46 320  
**RANGE OF TEMPERATURE** -40°C +100°C

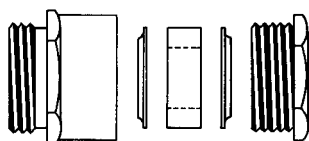
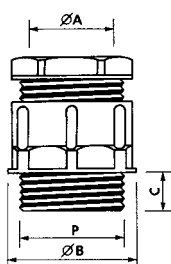

### FILETTO PASSO PG / PG THREAD

ARTICOLO ARTICLE	PASSO THREAD P	Ø A MIN-MAX (mm)	FORO FISSAGGIO FIXING HOLE (mm)	B CHIAVE SPANNER (mm)	C (mm)	PEZZI PER CONFEZ. PCS PER PACK.
PG0	PG7	4-6	13	14	5	100
PG1	PG9	8-10	15,5	17	6	100
PG2	PG11	8-10	19	20	6	100
PG3	PG13,5	10-12	21	22	6,5	50
PG4	PG16	12-14	23	24	6,5	50
PG5	PG21	17-19	29	30	7	50
PG6	PG29	26-28	37,5	40	8	25
PG7	PG36	33-35	47,5	50	9	10
PG8	PG42	39-41	54,5	57	10	10
PG9	PG48	43-45	60	64	10	10

## DADI ESAGONALI / HEXAGONAL LOCK NUT



CE

- **DIMENSIONI** a norma DIN  
**TESTINE** DIN 46 320  
**DADI** DIN 46 320 FORM M-NS
- **SIZES** compliant to DIN  
**PRESSING-SCREW** DIN 46 320  
**LOCK NUT** DIN 46320 FORM M-NS

### FILETTO PASSO PG / PG THREAD

ARTICOLO ARTICLE	PASSO THREAD P	A (mm)	H (mm)	PEZZI PER CONFEZ. PCS PER PACK.
PGR0	PG7	15	2,8	100
PGR1	PG9	18	2,8	100
PGR2	PG11	21	3	100
PGR3	PG13,5	23	3	50
PGR4	PG16	26	3	50
PGR5	PG21	32	3,5	50
PGR6	PG29	41	4	25
PGR7	PG36	51	5	10
PGR8	PG42	60	5	10
PGR9	PG48	64	5,5	10

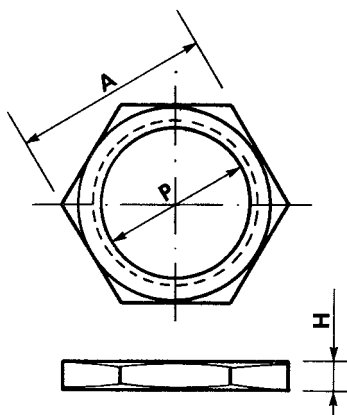

# PRESSACAVI ANTISTRAPPO IN OTTONE NICHELATO COMPLETI DI DADO / STRESS RELIEF NICKEL BRASS CABLE GLANDS WITH LOCK NUT INCLUDED

## FILETTO PASSO METRICO / METRIC THREAD

CE



- **MATERIALE**  
Ottone nichelato
- **GRADO DI PROTEZIONE**  
IP68
- **MATERIAL**  
Nickel brass
- **PROTECTION DEGREE**  
IP68

### FORNITI COMPLETI DI DADO / LOCK NUT INCLUDED

ARTICOLO ARTICLE	PASSO THREAD P	FILETTO PITCH	D2	B1	L1	L2	L3	Ø CAVO CABLE RANGE	PEZZI PER CONFEZ. PCS PER PACK.
EAG12/OT	M12	1,5	7,5	6,6	5	10	12	3-6,5	50
EAG16/OT	M16	1,5	10,5	8,5	5	12	14	5-9,5	50
EAG20/OT	M20	1,5	14,5	12	6	12	16	10-12,5	50
EAG25/OT	M25	1,5	17,5	15,5	7	20	17	13-16,5	50
EAG32/OT	M32	1,5	22,5	21	8	15	18,5	18-21,5	25
EAG40/OT	M40	1,5	29	27,5	8	17	22	22-28	10
EAG50/OT	M50	1,5	37	35	9	20	25	30-37	10
EAG63/OT	M63	1,5	50,5	48	10	22	27	34-48	10

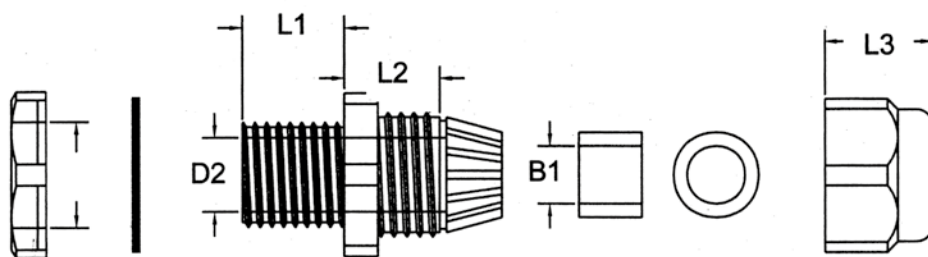

# PRESSACAVI ANTISTRAPPO IN NYLON / NYLON STRESS RELIEF CABLE GLANDS



CE

- MATERIALE** Nylon 66 94V-2 approvato UL  
**GRADO DI PROTEZIONE** IP68  
**TEMPERATURA D'ESERCIZIO** -40°C + 85°C

DISPONIBILI IN COLORE GRIGIO O NERO  
 FORNITI COMPLETI DI DADO  
 GUARNIZIONI PIANE A PARTE

- MATERIAL** UL Approved Nylon 66 94V-2  
**PROTECTION DEGREE** IP68  
**RANGE OF TEMPERATURE** -40°C + 85°C

AVAILABLE IN GREY OR BLACK COLOUR  
 LOCK NUT INCLUDED  
 WASHER NOT INCLUDED

## FILETTO PASSO PG / PG THREAD

ARTICOLO ARTICLE	PASSO THREAD P	FILETTO PITCH	FORO FISSAGGIO FIXING HOLE	D2	B1	L1	L2	L3	Ø CAVO CABLE RANGE	PEZZI PER CONFEZ. PCS PER PACK.	GUARNIZIONI PIANE WASHER
EG-7	PG-7	1,5	12,5	8,3	6,9	7,9	20	13,3	3,5-6	50	GP/EG7
EG-9	PG-9	1,5	15	10,5	8	7,9	22	15,1	4-8	50	GP/EG9
EG-11	PG-11	1,5	18,3	13,2	10,5	7,9	23,7	18,3	5-10	50	GP/EG11
EG-13,5	PG-13,5	1,5	20,4	15,5	12	8,9	24,6	18,9	6-12	50	GP/EG13,5
EG-16	PG-16	1,5	22,5	17,2	14	9,8	26,2	19,5	10-14	50	GP/EG16
EG-21	PG-21	1,5	28,3	22,4	18,4	10,8	30	23,7	13-18	50	GP/EG21
EG-29	PG-29	1,5	37	30,6	25	10,8	35	27,4	18-25	25	GP/EG29
EG-36	PG-36	1,5	47	35,3	35,5	14,5	42,3	30,3	22-32	10	GP/EG36
EG-42	PG-42	1,5	54	40	40	14,5	44	31,2	30-38	10	GP/EG42
EG-48	PG-48	1,5	59,3	46,2	46	15,6	42,7	31,3	34-44	10	GP/EG48

## SERIE FILETTO LUNGO / LONG THREAD SERIES

### FILETTO PASSO PG / PG THREAD

ARTICOLO ARTICLE	PASSO THREAD P	FILETTO PITCH	FORO FISSAGGIO FIXING HOLE	D2	B1	L1	L2	L3	Ø CAVO CABLE RANGE	PEZZI PER CONFEZ. PCS PER PACK.
EG-9L	PG-9	1,5	15,2	10,5	8	14,7	22	15,1	4-8	50
EG-11L	PG-11	1,5	18,3	13,2	10,5	15	23,7	18,3	5-10	50
EG-13,5L	PG-13,5	1,5	20,4	15,5	12	15,8	24,6	18,9	6-12	50

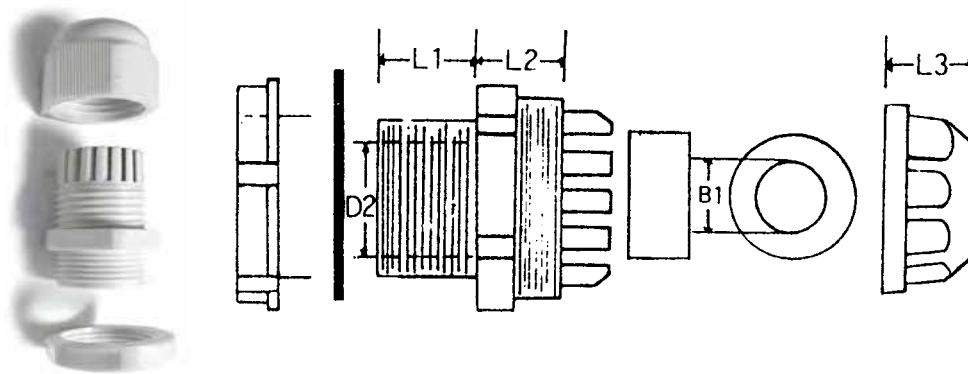

# PRESSACAVI ANTISTRAPPO IN NYLON / NYLON STRESS RELIEF CABLE GLANDS

## TAPPO CIECO / BLINDING PLUGS



A RICHIESTA DISPONIBILI ANCHE NERI  
ON REQUEST AVAILABLE ALSO IN BLACK COLOUR

ARTICOLO / ARTICLE	PASSO / THREAD	PEZZI PER CONFEZ. PCS PER PACK.
TP7	PG7	100
TP9	PG9	100
TP11	PG11	100
TP13,5	PG13,5	100
TP16	PG16	100
TP21	PG21	50
TP29	PG29	50
TP36	PG36	25
TP42	PG42	10
TP48	PG48	10

PASSO PG / PG THREAD

## PRESSACAVI ANTISTRAPPO IN NYLON - SERIE CON PROTEZIONE A SPIRALE COMPLETI DI DADO / NYLON STRESS RELIEF CABLE GLANDS - SERIES WITH SPIRAL PROTECTION WITH LOCK NUT INCLUDED

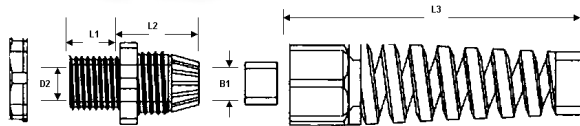

**MATERIALE** Nylon 66 94V-2 approvato UL  
**TEMPERATURA D'ESERCIZIO** -40°C + 85°C  
COLORE STANDARD NERO (GRIGIO A RICHIESTA)

**MATERIAL** UL Approved Nylon 66 94V-2  
**RANGE OF TEMPERATURE** -40°C + 85°C  
STANDARD COLOR BLACK (GREY ON REQUEST)

PASSO PG / PG THREAD

ARTICOLO ARTICLE	PASSO THREAD P	FILETTO PITCH	FORO FISSAGGIO FIXING HOLE	D2	B1	L1	L2	L3	Ø CAVO CABLE RANGE	PEZZI PER CONFEZ. PCS PER PACK.
EG-7/SR	PG-7	1,5	12,5	8,3	6,9	7,9	20	53,3	3,5-6	50
EG-9/SR	PG-9	1,5	15,2	10,5	8	7,9	22	69,5	4-8	50
EG-11/SR	PG-11	1,5	18,3	13,2	10,5	7,9	23,7	74,9	5-10	50
EG-13,5/SR	PG-13,5	1,5	20,4	15,5	12	8,9	24,6	85,5	6-12	50
EG-16/SR	PG-16	1,5	22,5	17,2	14	9,8	26,2	96,2	10-14	50
EG-21/SR	PG-21	1,5	28,3	22,4	18,4	10,8	30	111,2	13-18	50

## PRESSACAVO ANTISTRAPPO CURVO A 90° COMPLETO DI DADO / STRESS RELIEF CABLE GLANDS BENT TO 90° WITH LOCK NUT INCLUDED

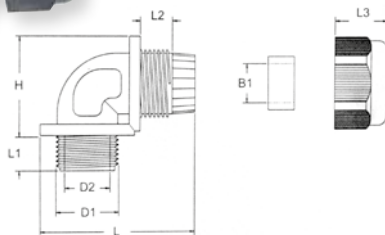

**MATERIALE** Nylon 66 94V-2 approvato UL  
**TEMPERATURA D'ESERCIZIO** -40°C + 85°C  
COLORE NERO

**MATERIAL** UL Approved Nylon 66 94V-2  
**RANGE OF TEMPERATURE** -40°C + 85°C  
COLOR BLACK



ARTICOLO ARTICLE	PASSO THREAD P	FORO FISSAGGIO FIXING HOLE	D2	B1	L1	L2	L3	L	H	Ø CAVO CABLE RANGE	PEZZI PER CONFEZ. PCS PER PACK.
ENPTA-38	NPT 3/8"	16,7	12	9,3	11,7	9,85	16,7	48,5	30	5-9	20
ENPTA-12	NPT 3/8"	21,2	14	14,5	14,7	11,75	18,4	51,6	31,2	10-13	20
ENPTA-34	NPT 3/8"	26,3	19,2	16,4	14,8	12,55	22,3	64,5	41,6	13-16	20
ENPTA-114	NPT 3/8"	41,9	31,6	29,3	18,8	16,25	31	85	53	22-29	20

# PRESSACAVI ANTISTRAPPO IN NYLON / NYLON STRESS RELIEF CABLE GLANDS



CE

- **MATERIALE** Nylon 66 94V-2 approvato UL  
**GRADO DI PROTEZIONE** IP68  
**TEMPERATURA D'ESERCIZIO** -40°C + 85°C

DISPONIBILI IN COLORE GRIGIO O NERO  
FORNITI COMPLETI DI DADO

- **MATERIAL** UL Approved Nylon 66 94V-2  
**PROTECTION DEGREE** IP68  
**RANGE OF TEMPERATURE** -40°C + 85°C

AVAILABLE IN GREY OR BLACK COLOUR  
LOCK NUT INCLUDED

## PASSO METRICO / METRIC THREAD

ARTICOLO ARTICLE	PASSO THREAD P	FILETTO PITCH	D2	B1	L1	L2	L3	Ø CAVO CABLE RANGE	PEZZI PER CONFEZ. PCS PER PACK.
EAG-12	M12	1,25	8,3	6,9	7,9	19,2	13,6	3-6,5	50
EAG-16	M16	1,5	10,9	10,5	15,5	19,6	16,9	5-10	50
EAG-20	M20	1,5	15	14	15	28,5	18,5	10-14	50
EAG-25	M25	1,5	18,6	18,4	15,2	29,4	22,3	13-18	50
EAG-32	M32	1,5	26	25	14,7	34,5	25,7	18-25	25
EAG-40	M40	1,5	33,7	33	18,4	41,7	31,3	22-32	10
EAG-50	M50	1,5	41,9	40	17,8	44,2	31,3	30-38	10
EAG-63	M63	1,9	55	44	18,5	44,6	32,7	34-44	10
EAG-63L	M63	1,9	56,6	51,5	25,4	49	36,8	42-50	10

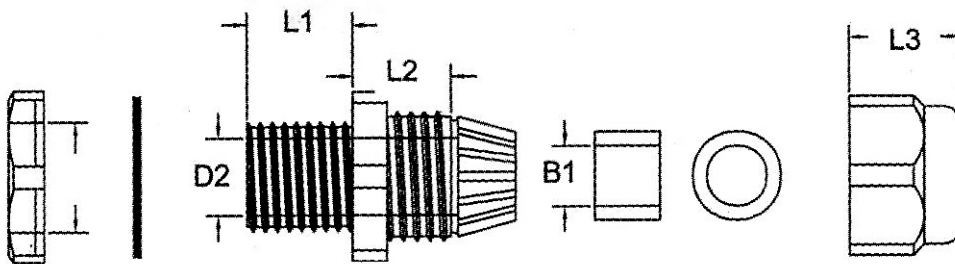

## TAPPO CIECO / BLINDING PLUG



A RICHIESTA DISPONIBILI ANCHE NERI  
ON REQUEST AVAILABLE ALSO IN BLACK COLOUR

PASSO METRICO  
METRIC THREAD

ARTICOLO / ARTICLE	PASSO / THREAD	PEZZI PER CONFEZ. PCS PER PACK.
TPM12	M12	100
TPM16	M16	100
TPM20	M20	100
TPM25	M25	100
TPM32	M32	50
TPM40	M40	25
TPM50	M50	25
TPM63	M63	10

# PRESSACAVI E DADI IN PLASTICA / PLASTIC CABLE GLANDS AND LOCK NUT

CE



—● **MATERIALE** Plastica antiurto con guarnizioni in gomma

**GRADO DI PROTEZIONE** IP54

**TEMPERATURA D'ESERCIZIO** -30°C + 60°C

—● **MATERIAL** Plastic with rubber washer

**PROTECTION DEGREE** IP54

**RANGE OF TEMPERATURE** -30°C + 60°C

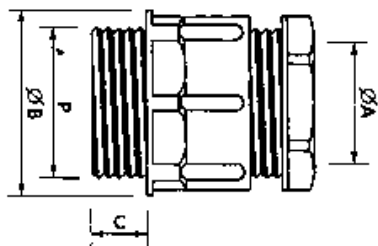

FILETTO PASSO PG - DIN 40 430 / PG THREAD - DIN 40 430

ARTICOLO ARTICLE	PASSO THREAD P	Ø A MIN-MAX (mm)	FORO FISSAGGIO FIXING HOLE (mm)	B CHIAVE SPANNER (mm)	C (mm)	PEZZI PER CONFEZ. PCS PER PACK.
709	PG7	3-6	13,5	15	8	100
700	PG9	4,5-7	15,5	19	8	100
701	PG11	6-9	19	22	8	100
702	PG13,5	9-12	20,5	24	9	100
703	PG16	11-14	23	27	10	100
704	PG21	14-18	28,5	33	11	50
705	PG29	18-25	37,5	42	11	50
706	PG36	25-32	47,5	53	13	25
707	PG42	39-41	54	60	14	10
708	PG48	40-44	60	68	14	10

## DADO / LOCK NUT

CE



—● **MATERIALE** Autoestinguente CL VO (UL 94)

**COLORE** grigio RAL 7035

**DIMENSIONI** a norma DIN 46 320 Form L-FS

—● **MATERIAL** Self-extinguishing CL VO (UL 94)

**COLOUR** Grey colour RAL 7035

**SIZES** compliant to DIN 46320 Form L-FS

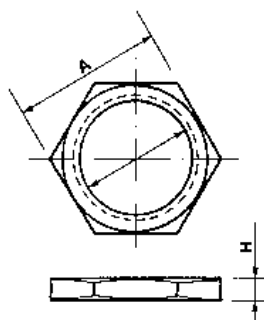

FILETTO PASSO PG - DIN 40 430 / PG THREAD - DIN 40 430

ARTICOLO ARTICLE	PASSO THREAD P	A (mm)	H (mm)	PEZZI PER CONFEZ. PCS PER PACK.
719	PG7	19	5	100
710	PG9	22	5	100
711	PG11	24	5	100
712	PG13,5	27	6	100
713	PG16	30	6	100
714	PG21	36	7	50
715	PG29	48	7	50
716	PG36	57	8	25
717	PG42	65	8	10
718	PG48	70	8	10



# FASCETTE IN NYLON - BIANCHE E NERE / NYLON CABLE TIES - WHITE OR BLACK COLOUR



CE

**MATERIALE** Nylon 66, approvato UL  
**CLASSE DI AUTOESTINGUENZA** 94V-2  
 Conforme alle norme MILS-23190E  
**TEMPERATURA D'ESERCIZIO** -40°C + 85°C  
**COLORE** Bianche e nere  
 Per usi esterni si consiglia il colore nero  
 Aggiungere /N dopo il codice fascetta  
 (Es. FCV075/N)

**MATERIAL** UL Approved Nylon 66  
**PROTECTION DEGREE** 94V-2  
 Compliant to MILS-23190E rules  
**RANGE OF TEMPERATURE** -40°C + 85°C  
**COLOUR** Black or white  
 It is suggested black colour for external use  
 Add /N after cable tie code (Ex. FCV075/N)

## FASCETTE / CABLE TIES



ARTICOLO ARTICLE	DESCRIZIONE LUNGHEZZA / LARGHEZZA DESCRIPTION LENGTH / WIDTH (mm)	TENUTA MINIMA TENSILE STRENGTH		PEZZI PER CONFEZ. PCS PER PACK.
		KG	LB	
FCV075	75 x 2,5	8	18	100/1000
FCV100	96 x 2,5	8	18	100/1000
FCV120	120 x 2,5	8	18	100/1000
FCV120L	120 x 4,8	22	50	100/1000
FCV135	142 x 2,5	8	18	100/1000
FCV140	142 x 3,2	18	40	100/1000
FCV160	165 x 2,5	8	18	100/1000
FCV160L	160 x 4,8	22	50	100/1000
FCV200M	200 x 2,5	8	18	100/1000
FCV200S	200 x 3,2	18	40	100/1000
FCV200	200 x 4,6	22	50	100/1000
FCV200L	200 x 7,6	55	120	100
FCV250	250 x 4,8	22	50	100
FCV250M	250 x 3,6	18	40	100
FCV265M	265 x 3,6	18	40	100
FCV290	292 x 3,6	18	40	100/1000
FCV300	300 x 7,6	55	120	100
FCV310	310 x 4,8	22	50	100
FCV360M	368 x 3,6	18	40	100
FCV360	368 x 4,8	22	50	100
FCV360L	380 x 7,6	55	120	100
FCV380	385 x 4,8	22	50	100
FCV432	432 x 4,8	22	50	100
FCV550	550 x 8	80	175	100
FCV762	762 x 9	80	175	50
FCV914	914 x 9	80	175	50
FCV1030	1030 x 12,7	114	250	50
FCV1168	1168 x 9	80	175	50

## FASCETTE CON OCCHIELLO / RING CABLE TIES



ARTICOLO ARTICLE	DESCRIZIONE LUNGHEZZA / LARGHEZZA DESCRIPTION LENGTH / WIDTH (mm)	TENUTA MINIMA TENSILE STRENGTH		PEZZI PER CONFEZ. PCS PER PACK.
		KG	LB	
FCV205/2 PER VITE 5,2	221,3 x 4,2	18	40	100

## FASCETTE CON IDENTIFICAZIONE / MARKER TIES

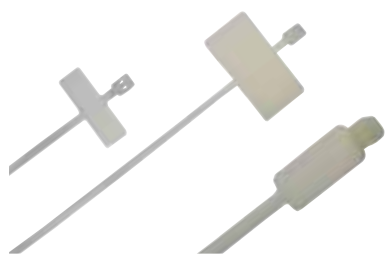

ARTICOLO ARTICLE	DESCRIZIONE LUNGHEZZA / LARGHEZZA DESCRIPTION LENGTH / WIDTH (mm)	TENUTA MINIMA TENSILE STRENGTH		PEZZI PER CONFEZ. PCS PER PACK.
		KG	LB	
<b>FCV100/3</b> orizzontale 25x8	100 x 2,5	8	18	100
<b>FCV200/3</b> verticale 28x13	200 x 4,6	18	50	100
<b>FCV200S/3</b> orizzontale 30x15	200 x 2,5	18	8	100

## PINZE PER FASCETTE SERIE FCV / TOOLS FOR CABLE TIES FCV SERIES



### ART. 70

Pinza in plastica per fascette 2,5-5 mm  
Plastic tool for cable ties 2,5-5 mm



### ART. 71

Pinza professionale in plastica per fascette 2,5-5 mm  
Professional plastic tool for cable ties 2,5-5 mm



### ART. 71M

Pinza professionale in metallo per fascette 2,2-4,8 mm  
Professional metal tool for cable ties 2,2-4,8 mm

## RILEGA FASCETTE AUTOADESIVO / SELF-ADHESIVE TIE MOUNT



ARTICOLO ARTICLE	DIMENSIONE DIMENSION	SPESSORE THICKNESS	PEZZI PER CONFEZ. PCS PER PACK.
<b>FHC101</b>	21 x 21	4	100
<b>FHC102</b>	28 x 28	5,3	100

A RICHIESTA DISPONIBILI ANCHE DI COLORE NERO  
ON REQUEST AVAILABLE ALSO IN BLACK COLOUR

## SPIRALE AVVOLGICAVI / BINDING BONDS



**MATERIALE** Polietilene

**MATERIAL** Polyethylene

CE



- Colore nero a richiesta (/N)
- Prezzo di listino inteso per 100 metri
- A richiesta disponibile anche autoestinguente

- Black colour on request (/N)
- Price list for 100 meters
- On request available also self extinguishing

ARTICOLO ARTICLE	D	D1	W	PEZZI PER CONFEZ. PCS PER PACK.
<b>FKS-6</b>	4	6	7	10 MT
<b>FKS-8</b>	6	8	10,8	10 MT
<b>FKS-10</b>	7,5	10	11,4	10 MT
<b>FKS-12</b>	9	12	13,9	10 MT

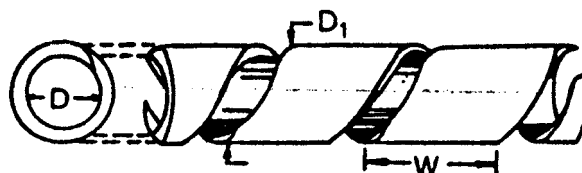

## FASCETTE IN NYLON - NERE NYLON CABLE TIES - BLACK COLOUR

CE



- MATERIALE** Nylon 66, approvato UL
- CLASSE DI AUTOESTINGUENZA** 94V-2  
Conforme alle norme MILS-23190E
- TEMPERATURA D'ESERCIZIO** -40°C + 85°C
- COLORE** Nero

- MATERIAL** UL Approved Nylon 66
- PROTECTION DEGREE** 94V-2  
Compliant to MILS-23190E rules
- RANGE OF TEMPERATURE** -40°C + 85°C
- COLORE** Black

## FASCETTE PER USO IN ESTERNO CON SISTEMA DI BLOCCAGGIO / CABLE TIES WITH BLOC SYSTEM FOR EXTERNAL USE

ELEVATA RESISTENZA ALLA TRAZIONE - COLORE NERO

HIGH STRENGTH - BLACK COLOUR



### ART. 72

Pinza in metallo per fascette 5-9 mm  
Metal tool for cable ties 5-9 mm

ARTICOLO ARTICLE	DESCRIZIONE LUNGHEZZA / LARGHEZZA DESCRIPTION LENGTH / WIDTH (mm)	TENUTA MINIMA TENSILE STRENGTH	PEZZI PER CONFEZ. PCS PER PACK.
		KG	
<b>FDL132</b>	132 x 9	36	100
<b>FDL180</b>	180 x 9	36	100
<b>FDL235</b>	235 x 9	55	100
<b>FDL265</b>	265 x 9	55	100
<b>FDL300</b>	300 x 9	55	100
<b>FDL360</b>	360 x 9	55	100
<b>FDL510</b>	510 x 9	55	100
<b>FDL610</b>	610 x 9	55	100
<b>FDL760</b>	760 x 9	55	100

## FISSATUBO A PRESSIONE / PRESSURE CLIPS

- MATERIALE** Polipropilene con fibra di vetro
- TEMPERATURA D'ESERCIZIO** -25 +85°C
- COLORE** Grigio RAL7035

- MATERIAL** Polypropylene with fibreglass
- RANGE OF TEMPERATURE** -25 +85°C
- COLORE** Grey RAL7035

CE

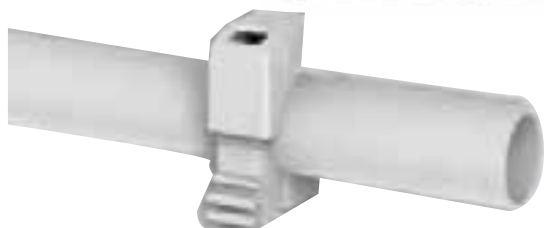

ARTICOLO ARTICLE	PER TUBI, GUAINE E CAVI FOR TUBES, SHEAT AND CABLES Ø	PEZZI PER CONFEZ. PCS PER PACK.
<b>601</b>	12-20	100
<b>602</b>	20-32	50
<b>603</b>	35-55	50

## UTENSILI MECCANICI / CRIMPING TOOLS

### PINZE PER TUBETTI TERMINALI NUDI E PREISOLATI

### TOOLS SUITABLE FOR INSULATED AND NON INSULATED END FERRULES



#### ART. 102T

- Pinza per tubetti nudi e preisolati da 0,5 a 2,5 mm<sup>2</sup>
- Tool suitable for insulated and non insulated end ferrules from 0,25 to 2,5 mm<sup>2</sup>

#### ART. 103T

- Pinza per tubetti nudi e preisolati da 0,75 a 10 mm<sup>2</sup>
- Tool suitable for insulated and non insulated end ferrules from 0,75 to 10 mm<sup>2</sup>



#### ART. 39

- Pinza a cricchetto per tubetti nudi e preisolati da 0,5 a 6 mm<sup>2</sup>
- Ratchet tool suitable for insulated and non insulated end ferrules from 0,5 to 6 mm<sup>2</sup>

#### ART. 40

- Pinza a cricchetto per tubetti nudi e preisolati da 0,5 a 6 mm<sup>2</sup>
- Ratchet tool suitable for insulated and non insulated end ferrules from 0,5 to 6 mm<sup>2</sup>



#### ART. 41

- Pinza a cricchetto per tubetti nudi e preisolati da 6 a 16 mm<sup>2</sup>
- Ratchet tool suitable for insulated and non insulated end ferrules from 6 to 16 mm<sup>2</sup>

#### ART. 42

- Pinza a cricchetto per tubetti nudi e preisolati da 25 a 50 mm<sup>2</sup>
- Ratchet tool suitable for insulated and non insulated end ferrules from 25 to 50 mm<sup>2</sup>



#### ART. 43

- Pinza a cricchetto per tubetti nudi e preisolati da 50 a 95 mm<sup>2</sup>
- Ratchet tool suitable for insulated and non insulated end ferrules from 50 to 95 mm<sup>2</sup>

#### ART. 44

- Pinza per tubetti nudi e preisolati da 70 a 150 mm<sup>2</sup>  
Matrici: M1/44120T - M1/44150T
- Tool suitable for insulated and non insulated end ferrules from 70 to 150 mm<sup>2</sup>  
Dies M1/44120T - M1/44150T

A RICHIESTA

## UTENSILI MECCANICI / CRIMPING TOOLS



### ART. 39/ESAG

- Pinza a cricchetto per tubetti nudi e preisolati da 0,5 a 6 mm<sup>2</sup> con chiusura esagonale
- *Ratchet tool suitable for insulated and non insulated end ferrules from 0,5 to 6 mm<sup>2</sup> with hexagonal closure*

### ART. 39S

- Pinza a cricchetto per tubetti nudi e preisolati da 0,08 a 10 mm<sup>2</sup>
- *Ratchet tool suitable for insulated and non insulated end ferrules from 0,08 to 10 mm<sup>2</sup>*



### ART. 39BIS

- Pinza a cricchetto per tubetti nudi e preisolati da 0,5 a 16 mm<sup>2</sup>
- *Ratchet tool suitable for insulated and non insulated end ferrules from 0,5 to 16 mm<sup>2</sup>*

### ART. 42BIS

- Pinza a cricchetto per tubetti nudi e preisolati da 10 a 50 mm<sup>2</sup>
- *Ratchet tool suitable for insulated and non insulated end ferrules from 10 to 50 mm<sup>2</sup>*



## PINZE PER CAPICORDA PREISOLATI TOOLS SUITABLE FOR PRE-INSULATED TERMINALS

### ART. 53

- Pinza manuale per capicorda nudi e preisolati da 0,25 a 6 mm<sup>2</sup>
- *Tool suitable for pre-insulated and non insulated terminals from 0,25 to 6 mm<sup>2</sup>*



### ART. 54

- Pinza per capicorda preisolati doppia aggraffatura da 0,25 a 6 mm<sup>2</sup>. Taglia e spella fili
- *Tool suitable for pre-insulated terminals double crimping from 0,25 to 6 mm<sup>2</sup>. Cut and wire stripper*

### ART. 60

- Pinza a cricchetto per capicorda preisolati da 0,25 a 6 mm<sup>2</sup>
- Doppia aggraffatura e punzonatura con controllo qualità
- *Ratchet tool suitable for pre-insulated terminals from 0,25 to 6 mm<sup>2</sup>*
- *Double crimping and control quality punching*



## UTENSILI MECCANICI / CRIMPING TOOLS

### PINZE PER CAPICORDA APERTI

### TOOLS SUITABLE FOR OPEN QUICK CONNECT TERMINALS

#### —● ART. 50

- Pinza per capicorda aperti da 0,25 a 6 mm<sup>2</sup>
- Tool suitable for open quick connect terminals from 0,25 to 6 mm<sup>2</sup>



#### —● ART. 51

- Pinza a cricchetto per capicorda aperti da 0,5 a 6 mm<sup>2</sup>
- Ratchet tool suitable for open quick connect terminals from 0,5 to 6 mm<sup>2</sup>



#### —● ART. 51R

- Pinza a cricchetto per capicorda aperti da 0,5 a 2,5 mm<sup>2</sup>
- Ratchet tool suitable for open quick connect terminals from 0,5 to 2,5 mm<sup>2</sup>



#### —● ART. 51C

- Pinza a cricchetto per faston a bandiera tipo B02/BAND
- Ratchet tool suitable for flag faston type B02/BAND



#### —● ART. 51B

- Pinza manuale per capicorda aperti da 0,25 a 6 mm<sup>2</sup>
- Manual tool suitable for open quick connect terminals from 0,25 to 6 mm<sup>2</sup>



## PINZE A CRICCHETTO PER CAPICORDA NUDI - AGGRAFFATURA A PUNZONE RATCHET TOOLS SUITABLE FOR NON-INSULATED TERMINALS - PUNCH CRIMPING

#### —● ART. 52

- Pinza a cricchetto per capicorda nudi da 1,5 a 10 mm<sup>2</sup>
- Manual tool suitable for open quick connect terminals from 0,25 to 6 mm<sup>2</sup>



#### —● ART. 52BIS

- Pinza a cricchetto per capicorda nudi da 10 a 16 mm<sup>2</sup>
- Ratchet tool suitable for non insulated terminals from 10 to 16 mm<sup>2</sup>



## UTENSILI MECCANICI / CRIMPING TOOLS

### PINZE MANUALI PER CAPICORDA NUDI - AGGRAFFATURA A PUNZONE MANUAL TOOLS SUITABLE FOR NON-INSULATED TERMINALS - PUNCH CRIMPING

#### —● ART. CT38

- Pinza manuale per capicorda nudi da 10 a 50 mm<sup>2</sup>
- *Manual tool suitable for non-insulated terminals from 10 to 50 mm<sup>2</sup>*



#### —● ART. CT100

- Pinza manuale per capicorda nudi da 25 a 120 mm<sup>2</sup>
- *Manual tool suitable for non-insulated terminals from 25 to 120 mm<sup>2</sup>*

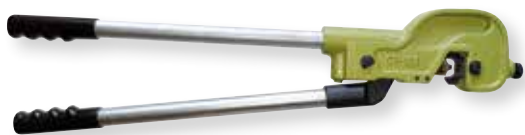

#### —● ART. CT150

- Pinza manuale per capicorda nudi da 10 a 150 mm<sup>2</sup>
- *Manual tool suitable for non-insulated terminals from 10 to 150 mm<sup>2</sup>*



#### —● ART. 56

- Pinza manuale per capicorda nudi con manici allungabili da 10 a 185 mm<sup>2</sup>
- *Manual tool with extendable handles suitable for non-insulated terminals from 10 to 185 mm<sup>2</sup>*



#### —● ART. 57

- Pinza manuale per capicorda nudi da 10 a 120 mm<sup>2</sup>
- *Manual tool suitable for non-insulated terminals from 10 to 120 mm<sup>2</sup>*



#### —● ART. 57BIS

- Pinza manuale per capicorda nudi da 10 a 120 mm<sup>2</sup>
- *Manual tool suitable for non-insulated terminals from 10 to 120 mm<sup>2</sup>*



### PINZE MANUALI PER CAPICORDA NUDI - AGGRAFFATURA ESAGONALE MANUAL TOOLS SUITABLE FOR NON-INSULATED TERMINALS - HEXAGONAL CRIMPING

#### —● ART. HX50

- Pinza manuale per capicorda nudi da 10 a 50 mm<sup>2</sup>
- *Manual tool suitable for non-insulated terminals from 10 to 50 mm<sup>2</sup>*



#### —● ART. HX120B

- Pinza manuale per capicorda nudi da 10 a 120 mm<sup>2</sup>
- *Manual tool suitable for non-insulated terminals from 10 to 120 mm<sup>2</sup>*



## UTENSILI MECCANICI / CRIMPING TOOLS

### PINZE IDRAULICHE MANUALI E A BATTERIA PER CAPICORDA NUDI AGGRAFFATURA A PUNZONE ED ESAGONALE

### MANUAL AND BATTERY HYDRAULIC TOOLS SUITABLE FOR NON-INSULATED TERMINALS - HEXAGONAL AND PUNCH CRIMPING

#### —● ART. 55

- Pinza idraulica manuale per capicorda nudi da 10 a 240 mm<sup>2</sup> (matrici esagonali non incluse - Tabella matrici a pag. 31)
- *Manual hydraulic tool suitable for non-insulated terminals from 10 to 240 mm<sup>2</sup> (dies not included - dies tab available at pag. 31)*



#### —● ART. 55BAT

- Pinza idraulica a batteria per capicorda nudi da 10 a 240 mm<sup>2</sup> (matrici esagonali non incluse - Tabella matrici a pag. 31). Completa di cassetta e caricabatteria
- *Battery hydraulic tool suitable for non-insulated terminals from 10 to 240 mm<sup>2</sup> (dies not included - dies tab available at pag. 31). Complete with carrying case and battery charger*



#### —● ART. 58

- Pinza idraulica manuale per capicorda nudi da 10 a 300/400 mm<sup>2</sup> (matrici non incluse - Tabella matrici a pag. 32)
- *Manual hydraulic tool suitable for non-insulated terminals from 10 to 300/400 mm<sup>2</sup> (dies not included - dies tab available at pag. 32)*



### POMPE IDRAULICHE A PEDALE PER CAPICORDA NUDI - AGGRAFFATURA A PUNZONE ED ESAGONALE

### FOOT LEVER HYDRAULIC PUMP SUITABLE FOR NON-INSULATED TERMINALS HEXAGONAL AND PUNCH CRIMPING

#### —● ART. 59

- Centralina oleodinamica a pedale per capicorda nudi da 10 a 630 mm<sup>2</sup>. Completa di testa (escluse matrici - Tabella matrici a pag. 33)
- *Foot lever hydraulic pump suitable for non-insulated terminals from 10 to 630 mm<sup>2</sup>. Complete with head (dies not included - dies tab available at pag. 33)*



#### —● ART. 59BIS

- Pompa idraulica a pedale. Pressione d'esercizio 700 bar
- *Foot lever hydraulic pump. Pressure 700 bar*

#### —● ART. EAP1000

- Pompa pneumodinamica a pedale completa di tubo ad alta pressione. Alimentazione 6-10 bar
- *Foot lever air hydraulic pump with high pressure tube included. Pressure 6-10 bar*





# UTENSILI MECCANICI / CRIMPING TOOLS

**TESTE OLEODINAMICHE** compatibili con pompe ART. 59BIS e ART. EAP1000  
**OLEODYNAMIC HEADS** compatible with pumps ART. 59BIS and ART. EAP1000

## ART. ETP-210

- Testa oleodinamica per sezioni da 25 a 240 mm<sup>2</sup>. Completa di punzoni
- *Oleodynamic head available for section from 16 to 240 mm<sup>2</sup>. Punches included*



## ART. ETP-325

- Testa oleodinamica per sezioni da 16 a 400 mm<sup>2</sup>. Completa di matrici e punzoni
- *Oleodynamic head suitable for section from 16 to 400 mm<sup>2</sup>. Punches and dies included*



## ART. ETP-800H

- Testa oleodinamica per sezioni da 35 a 630 mm<sup>2</sup>. Completa di matrici
- *Oleodynamic head suitable for section from 35 to 630 mm<sup>2</sup>. Dies included*



## ART. ETP-300/58

- Testa oleodinamica per sezioni da 10 a 300 mm<sup>2</sup>. Matrici non incluse. Compatibile con matrici ART. 58
- *Oleodynamic head for section from 10 to 300 mm<sup>2</sup>. Dies not included. Compatible with ART.58 dies*



## ART. ECO-630

- Testa oleodinamica per sezioni 300/400/500/630 mm<sup>2</sup>. Completa di matrici
- *Oleodynamic head suitable for section 300/400/500/630 mm<sup>2</sup>. Dies included*



## ART. EOP-1000

- Testa oleodinamica per sezioni da 400 a 1000 mm<sup>2</sup>. Completa di matrici. (500/630/800/1000)
- *Oleodynamic head suitable for section from 400 to 1000 mm<sup>2</sup>. Dies included. (500/630/800/1000)*



# UTENSILI MECCANICI / CRIMPING TOOLS

## PINZA PNEUMATICA PNEUMATIC CRIMPING TOOL

### ART. EPH 2000

- Pinza pneumatica con comando a pedale. Matrici escluse
- *Pneumatic crimping tool with foot lever control. Dies not included*



ARTICOLO ARTICLE	SEZIONE SECTION	APPLICAZIONI APPLICATIONS
M5/PH-16WF	6-16 mm <sup>2</sup>	TUBETTI/END FERRULES
M1/PH-03C	0,5-6 mm <sup>2</sup>	PREISOLATI/INSULATED TERMINALS
M7/PH-03B	0,5-6 mm <sup>2</sup>	NON ISOLATI IN OTTONE/ BRASS NOT INSUL.
M8/PH-10	1,5-10 mm <sup>2</sup>	NON ISOLATI/NOT INSULATED
M4/PH-04WF	0,5-4 mm <sup>2</sup>	TUBETTI/END FERRULES
M6/PH-C7	Ø 7 mm rame	PER TAGLIO CAVI/CABLE CUTTER



- **ARIA** 5-6 BAR  
**SCHIACCIATA** 1,3 Kn per BAR di pressione  
**PESO** 2,7 KG  
**DIMENSIONI** 225x135x90

- **AIR** 5-6 BAR  
**PRESSURE** 1,3 Kn per pression BAR  
**WEIGHT** 2,7 KG  
**DIMENSIONS** 225x135x90

## PINZE PER CONNETTORI DI CODA END CONNECTORS TOOLS

### ART. E13C

- Pinza a cricchetto per connettori di coda da 0,5 a 6 mm<sup>2</sup>.
- *Ratchet tool suitable for end connectors from 0,5 to 6 mm<sup>2</sup>*



### ART. E28C

- Pinza a cricchetto per connettori di coda da 4 a 10 mm<sup>2</sup>.
- *Ratchet tool suitable for end connectors from 4 to 10 mm<sup>2</sup>*

## PINZA PER CONNETTORI COASSIALI BNC TOOL SUITABLE FOR BNC COAX TERMINALS

### ART. 80

- Pinza a cricchetto per connettori coassiali BNC
- *Ratchet tool suitable for BNC coax terminals*



## UTENSILI MECCANICI / CRIMPING TOOLS

### SPELLAFILI WIRE STRIPPER

#### —● ART. 61

- Spellafili automatica per sezioni da 0,25 a 6 mm<sup>2</sup>
- *Automatic wire stripper suitable for section from 0,25 to 6 mm<sup>2</sup>*



#### —● ART. 61BIS

- Spellafili automatica per sezioni da 0,25 a 6 mm<sup>2</sup>
- *Automatic wire stripper suitable for section from 0,25 to 6 mm<sup>2</sup>*



#### —● ART. 61TRIS

- Spellafili automatica per sezioni da 0,75 a 16 mm<sup>2</sup>
- *Automatic wire stripper suitable for section from 0,75 to 16 mm<sup>2</sup>*



### TRANCIACAVI CABLE CUTTER

#### —● ART. 62

- Tranciacavi a cricchetto per cavi con diametro fino a 32 mm. Solo per cavi (anime flessibili in rame e alluminio)
- *Ratchet cable cutter suitable for copper and aluminium cables with diameter up to 32 mm*



#### —● ART. 64

- Tranciacavi a cricchetto per cavi con diametro fino a 52 mm. Solo per cavi (anime flessibili in rame e alluminio)
- *Ratchet cable cutter suitable for copper and aluminium cables with diameter up to 52 mm*



#### —● ART. 65BIS

- Tranciacavi a cricchetto per cavi con diametro fino a 85 mm. Solo per cavi (anime flessibili in rame e alluminio)
- *Ratchet cable cutter suitable for copper and aluminium cables with diameter up to 85 mm*



## UTENSILI MECCANICI / CRIMPING TOOLS



### ART. RYC325

- Tranciacavi per sezioni da 10 a 300 mm<sup>2</sup>. Solo per cavi (anime flessibili in rame e alluminio)
- *Cable cutter suitable for copper and aluminium cables for section from 10 to 300 mm<sup>2</sup>*

### ART. RYC500

- Tranciacavi per sezioni da 16 a 500 mm<sup>2</sup>. Solo per cavi (anime flessibili in rame e alluminio)
- *Cable cutter suitable for copper and aluminium cables for section from 16 to 500 mm<sup>2</sup>*



### ART. EHT-85

- Testa tranciacavi taglio a ghigliottina per cavi in rame o alluminio di diametro max 85 mm. Compatibile con pompa Art. 59
- *Cable cutter head with guillotine cut suitable for copper and aluminium cables with diameter max 85 mm. Compatible with pump Art. 59*

### ART. EYR513

- Tronchesino manuale per sezioni fino ad un massimo di 50 mm<sup>2</sup>
- *Manual cable cutter suitable for section up to max 50 mm<sup>2</sup>*



### ART. EYR514

- Tronchesino manuale per sezioni fino ad un massimo di 95 mm<sup>2</sup>
- *Manual cable cutter suitable for section up to max 95 mm<sup>2</sup>*

## FORBICE PER ELETTRICISTI ELECTRICIANS SCISSOR

### ART. EGI90F

- Forbice per elettricisti per tagliare e spellare fili e cavetti in rame o alluminio fino a 50 mm<sup>2</sup>
- Matrice per crimpare tubetti terminali (da 0,5 - 4 mm<sup>2</sup>) incorporata nel manico
- Completa di safety box con gancio da appendere alla cintura
- *Electricians scissor to cut and strip copper and aluminium cables & wires up to 50 mm<sup>2</sup>*
- *Die to crimp end terminals ferrules (from 0,5 to 4 mm<sup>2</sup>) incorporated in the handle.*
- *Safety box with hook to hang on the belt included*



# UTENSILI MECCANICI / CRIMPING TOOLS

## PINZE PER FASCETTE CABLE TIES TOOLS

### —● ART. 70

- Pinza in plastica per fascette di dimensione 2,5-5 mm
- *Plastic tool suitable for cable ties dimension 2,5-5 mm*



### —● ART. 71

- Pinza in plastica per fascette di dimensione 2,2-4,8 mm
- *Plastic tool suitable for cable ties dimension 2,2-4,8 mm*



### —● ART. 71M

- Pinza in metallo per fascette di dimensione 2,2-4,8 mm
- *Metal tool suitable for cable ties dimension 2,2-4,8 mm*

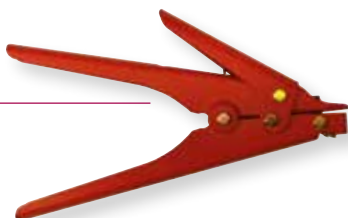

### —● ART. 72

- Pinza in metallo per fascette di dimensione 5-9 mm
- *Metal tool suitable for cable ties dimension 5-9 mm*

## SGUAINACAVI CABLE STRIPPER

### —● ART. 73

- Sguainacavi per sezioni da 0,4 a 25 mm di diametro
- *Cable stripper suitable for diameter section from 0,4 to 25 mm*



### —● ART. 74

- Sguainacavi per sezioni da 35 a 50 mm di diametro
- *Cable stripper suitable for diameter section from 35 to 50 mm*



### —● CARATTERISTICHE

- lama idonea per tagliare e spellare
- perno anti-allentamento regolabile
- manici bi-componente
- pistoncini ammortizzanti
- lame in acciaio speciale inossidabile
- riduzione della forza fino al 50% attraverso il tagliacavo integrato
- lame con microdentatura
- alta capacità di taglio

### —● FEATURES

- *blade suitable to cut and strip cables*
- *adjustable anti-loosening pin*
- *bi-component handles*
- *shock absorbing pistons*
- *blades in special inox steel*
- *strength reduction up to 50% through cable cutter integrated*
- *serrated blades*
- *high cutting level*



PRESENTE COME SPONSOR A 3 EDIZIONI:  
2017 / 2018 / 2019

# MILANO RALLY SHOW

La kermesse automobilistica che si svolge nel cuore della città di Milano.

# Milano



# Dubai

...e quest'anno sarà presente anche al Milano Rally Show a Dubai!

## ESPOSIZIONE UNIVERSALE



## PMI NETWORK

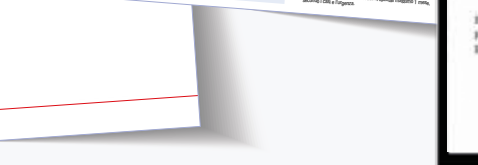

## MQ - Magazine Qualità - ONLINE



## STASERA ITALIA - RETE 4



EGI nella persona del suo titolare **Romano Saini**, è stata presente in molte trasmissioni televisive

COME ESEMPIO DI SUCCESSO DI UNA **PMI ITALIANA**

## ICEBERG - LA7



## PORTA A PORTA - RA1



## SKY



## TELELOMBARDIA



CI TROVI ANCHE SU





# EGI<sup>®</sup>

S.r.l.



## PRESENTI NEGLI ANNI NELLE PIU' IMPORTANTI FIERE DI SETTORE NEL MONDO!

## PRESENT OVER THE YEARS IN THE MOST IMPORTANT SECTOR FAIRS IN THE WORLD!



2015 e 2016

**PORDENONE**

COILTECH



2016 e 2017

**DUBAI**

MIDDLE EAST  
ELECTRICITY



2017

**PARMA**

SPS 2017



PARIGI

BOLOGNA

PARMA

MOSCA

SINGAPORE

MILANO

DUBAI

PORDENONE

CHICAGO

NAPOLI

TUNISI

PALEOMO

BERLINO

MONACO

VIENNA

MADRID

NUOVA DELHI

ISTANBUL





# EGI<sup>®</sup>

S.r.l.



## RICONOSCIMENTI AWARDS



**APOLLO D'ORO 1980**  
della Camera di Commercio  
Europea per le attività  
economiche

**AMBROGINO  
D'ORO**  
della Camera  
di Commercio  
di Milano per le  
esportazioni



Nel 2009 erano già 15 anni di attività in EGI e ora nel 2021, al traguardo del cinquantenario di EGI, **Simona Saini** è pronta per dare continuità all'azienda di famiglia e a raggiungere **NUOVI IMPORTANTI TRAGUARDI!**



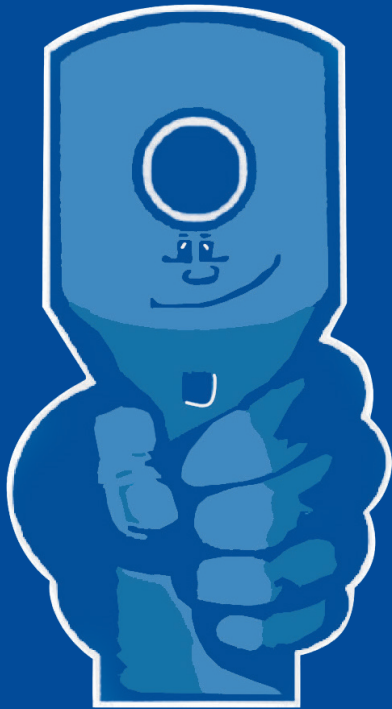



**EGI**®  
S.r.l.



**EGI Srl**

Via Gobetti 44 - Fizzonasco  
20072 Pieve Emanuele (Milano) - Italy

Tel. +39 02 90721944  
02 90725560  
02 90427184

Fax +39 02 90724646

info@egisrl.it

**WWW.EGISRL.IT**

A norma di legge è tassativamente vietata la riproduzione di questo catalogo o parte di esso con qualsiasi mezzo.  
La EGI si riserva di apportare variazioni e miglioramenti agli articoli senza obbligo di preavviso.  
*The reproduction of this catalog or part of it by any means is strictly prohibited  
EGI could modify or improve products without any notice*